

Attachment A8

**Traffic Impact Assessment - 15-25 Hunter
and 105-107 Pitt Street, Sydney**

BATES SMART ON BEHALF OF MILLIGAN
GROUP PTY LTD

MARCH 2022

15-21 HUNTER STREET AND 105-107 PITT STREET, SYDNEY

PRELIMINARY TRAFFIC IMPACT ASSESSMENT

wsp





Question today *Imagine tomorrow* Create for the future

15-21 Hunter Street and 105-107 Pitt Street, Sydney
Preliminary Traffic Impact Assessment
Bates Smart on behalf of Milligan Group Pty Ltd

WSP
Level 15, 28 Freshwater Place
Southbank VIC 3006

Phone: +61 3 9861 1111
Fax: +61 3 9861 1144
wsp.com

REV	DATE	DETAILS
H	23/03/2022	Area Update - Traffic Impact Assessment - Final

	NAME	DATE	SIGNATURE
Reviewed by:	Chris Hamond	10/02/2022	
Amended by:	Matthew Huynh	11/02/2022	
Approved by:	Chris Hamond	18/02/2022	

This document may contain confidential and legally privileged information, neither of which are intended to be waived, and must be used only for its intended purpose. Any unauthorised copying, dissemination or use in any form or by any means other than by the addressee, is strictly prohibited. If you have received this document in error or by any means other than as authorised addressee, please notify us immediately and we will arrange for its return to us.



TABLE OF CONTENTS

1	INTRODUCTION	1
1.1	PROJECT BRIEF	1
1.2	DEVELOPMENT SITE AND REPORT CONTEXT	1
1.3	REFERENCED DOCUMENTS	2
2	BACKGROUND AND EXISTING CONDITIONS	3
2.1	SITE LOCATION AND LAND USE	3
2.2	ROAD NETWORK	4
2.2.1	HUNTER STREET.....	4
2.2.2	PITT STREET.....	5
2.2.3	PITT STREET POP-UP CYCLEWAY	6
2.3	SUSTAINABLE TRANSPORT.....	7
2.3.1	PUBLIC TRANSPORT.....	7
2.3.2	WALKING	8
2.3.3	CYCLING.....	8
2.3.4	CAR SHARE.....	8
2.3.5	VEHICLE BOOKING SERVICES.....	9
3	PROPOSAL	10
4	PARKING REQUIREMENTS AND CONSIDERATIONS	11
4.1	CAR PARKING REQUIREMENTS	11
4.2	ACCESSIBLE CAR PARKING SPACES	12
4.3	CAR SHARE CONSIDERATIONS	13
4.4	MOTORCYCLE PARKING REQUIREMENTS	13
4.5	BICYCLE PARKING REQUIREMENTS	13
4.6	END-OF-TRIP FACILITIES.....	14
4.7	SERVICE VEHICLES.....	14
5	TRAFFIC GENERATION AND IMPACTS	15
5.1	ESTIMATED SITE GENERATED TRAFFIC.....	15
5.1.1	EMPIRICAL ASSESSMENT	15
5.1.2	CASE STUDY DATA ASSESSMENT	15
5.2	TRAFFIC IMPACTS	16
5.2.1	SINGLE ACCESS LANE	16
5.2.2	CAR STACKER QUEUE ANALYSIS	16
5.2.3	SERVICE VEHICLE LIFT	16
6	DESIGN CONSIDERATIONS	17
6.1	SITE ACCESS AND CIRCULATION	17

6.2	RAMP GRADES	17
6.3	CAR PARKING DESIGN	18
6.4	MECHANICAL PARKING	18
6.5	CAR LIFT	18
6.6	LOADING AND WASTE COLLECTION	19
7	CONCLUSION	20

LIST OF TABLES

TABLE 2.1	PUBLIC TRANSPORT OPTIONS	7
TABLE 4.1	STATUTORY CAR PARKING REQUIREMENTS	12
TABLE 4.2	STATUTORY BICYCLE PARKING REQUIREMENTS.....	13

LIST OF FIGURES

FIGURE 2.1	SITE LOCATION	3
FIGURE 2.2	HUNTER STREET FACING WEST.....	4
FIGURE 2.3	HUNTER STREET FACING EAST.....	4
FIGURE 2.4	PITT STREET FACING NORTH	5
FIGURE 2.5	PITT STREET FACING SOUTH.....	5
FIGURE 2.6	PITT STREET FACING NORTH	6
FIGURE 2.7	PITT STREET FACING SOUTH.....	6
FIGURE 2.8	GOGET CAR SHARE LOCATIONS	9

LIST OF APPENDICES

APPENDIX A	DEVELOPMENT PLANS
APPENDIX B	SWEPT PATH DIAGRAMS
APPENDIX C	MECHANICAL CAR STACKER AND CAR LIFT SPECIFICATIONS

1 INTRODUCTION

1.1 PROJECT BRIEF

This Traffic Impact Assessment has been prepared by WSP in support of a Planning Proposal to amend the Sydney Local Environmental Plan 2012 (Sydney LEP). This report has been prepared on behalf of Milligan Group Pty Ltd (the Proponent) and its related entities and consultants, representatives and agents and FT Sydney Pty Ltd as trustee for FT Sydney Unit Trust. It relates to an amalgamated site at 15-21 Hunter Street and 105-107 Pitt Street (the site).

The purpose of this Planning Proposal is to amend the site's Floor Space Ratio (FSR) development standard, and the Maximum Building Height to align with the Martin Place Sun Access Plane contained within the concurrent Central Sydney Planning Proposal.

This Planning Proposal supports the City of Sydney Council's draft Central Sydney Planning Strategy (Draft CSPA) by unlocking additional employment generating floor space within a designated tower cluster. The proposed Sydney LEP amendment is part of the broader redevelopment plan for the site to facilitate a new commercial office tower. It will also facilitate significant public benefits through additional site activation and embellishment of the public domain.

The Planning Proposal is accompanied by amendments to the Sydney Development Control Plan 2012 (Sydney DCP). The site specific DCP amendments reflect the proposed outcome to provide a podium tower scheme.

This is reflected in the accompanying reference design prepared by Bates Smart which serves as a baseline proof of concept for this Planning Proposal. This 2,108sqm strategic site presents a unique opportunity to deliver a landmark premium commercial office tower that will exhibit design excellence and offer significant employment opportunities for global Sydney.

The uplift being sought is consistent with the strategic intent of the draft CSPA, which contains the City's requirements and expectations for projects pursuing this pathway. Following the Planning Proposal, the planning approval pathway involves a competitive design process and a detailed Development Application. As such, this report reflects the concept stage of the proposal, and may be embellished as the detailed design and required works evolve.

1.2 DEVELOPMENT SITE AND REPORT CONTEXT

The development site will comprise the consolidation of five existing property titles as follows:

- 15-17 Hunter Street, Sydney (Comfort Hotel);
- 19-21 Hunter Street, Sydney;
- 23-25 Hunter Street (Currency House);
- 105 Pitt Street, Sydney; and
- 107 Pitt Street, Sydney.

This report discusses the traffic implications of the proposal, including the adequacy of parking provisions, the suitability of the site access arrangements, and the likely impacts on future traffic conditions.

1.3 REFERENCED DOCUMENTS

In the preparation of this assessment, the following documents have been referenced:

- Architectural Drawings prepared by Bates Smart dated March 2022;
- Sydney Local Environmental Plan 2012;
- Section 3 of the Sydney Development Control Plan 2012;
- Schedule 7 of the Sydney Development Control Plan 2012;
- Australian Standard AS2890.
- RTA Guide to Traffic Generating Developments (2002)
- RTA Guide to Traffic Generating Developments – Updated Traffic Surveys (Revision 4a – 2013)

In the course of undertaking this assessment, a desktop inspection of the subject site and surrounding road network has been undertaken to ascertain existing conditions.

The report concludes that the traffic and parking impacts are acceptable and further analysis will be undertaken at the detailed Development Application Stage.

2 BACKGROUND AND EXISTING CONDITIONS

2.1 SITE LOCATION AND LAND USE

The subject site is located within the Sydney CBD on the south-west corner of Hunter Street and Pitt Street, and is currently located across five existing property titles as follows:

- 15-17 Hunter Street, Sydney (Comfort Hotel);
- 19-21 Hunter Street, Sydney;
- 23-25 Hunter Street (Currency House);
- 105 Pitt Street, Sydney; and
- 107 Pitt Street, Sydney.

The proposed development has a site area of 2,108sqm, and has combined frontages of approximately 48.2 metres to Hunter Street along its northern boundary and 39.2 metres to Pitt Street along its eastern boundary. The subject site is currently occupied by a number of uses, including retail (food and drink), commercial and hotel.

In addition, the subject site is located within Sheet 14 of the Sydney LEP/DCP 2012 maps and is situated under the Metropolitan Centre (B8) Zone of the Sydney LEP. Further, the subject site is located on land in Category D under the Public Transport Accessibility Level (PTAL) Index.

Given its location within the Sydney CBD, the subject site is characterised by surrounding high density development, primarily containing commercial office and retail uses. The location of the subject site in the context of the surrounding road network is shown in Figure 2.1.

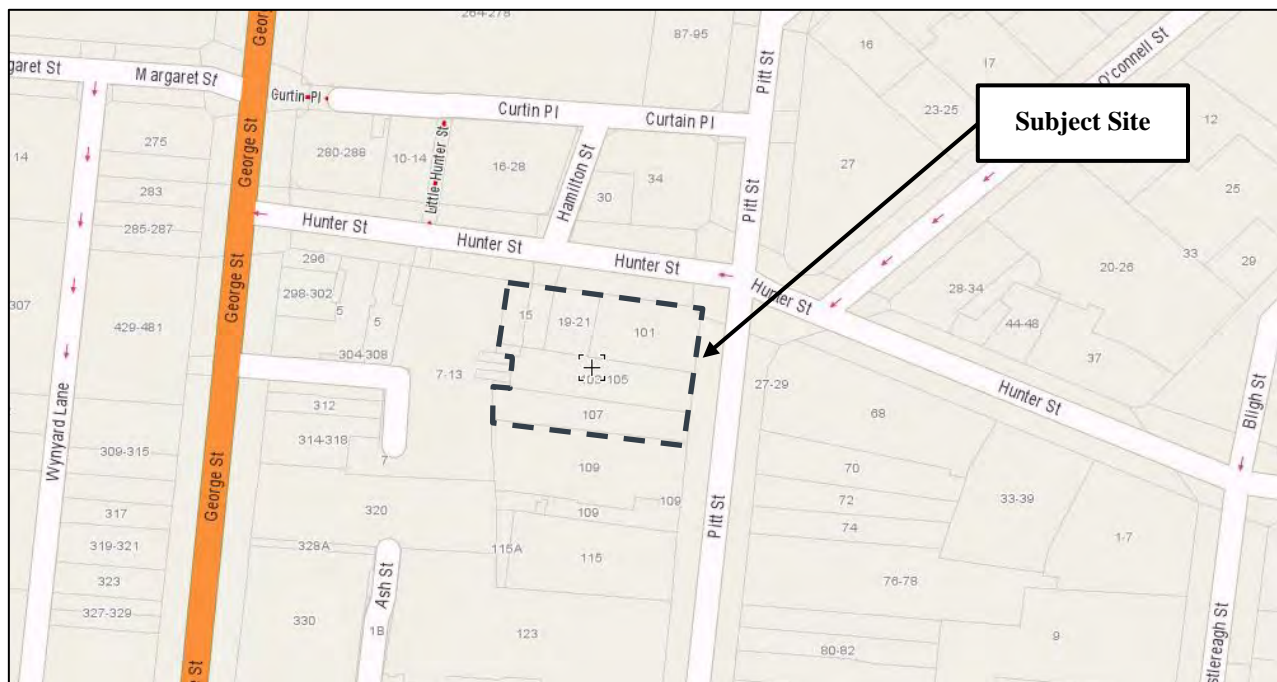

Source: www.street-directory.com.au

Figure 2.1 Site Location

2.2 ROAD NETWORK

2.2.1 HUNTER STREET

Hunter Street is a local road managed by the City of Sydney and is situated along the northern frontage of the site. Hunter Street is generally aligned in an east-west direction and typically comprises an approximate 14 metres wide carriageway along the site frontage, which accommodates two-way traffic movements. On-street kerbside parking is available on both sides within the vicinity of the site. Various parking restrictions apply along Hunter Street including, 4P ticket, 'Loading Zone', 'Taxi Zone', and 'No Stopping'.

A 40km/h speed limit applies within the Sydney city centre, including Hunter Street. There is no existing vehicular access to the subject site from Hunter Street.

Figure 2.2 and Figure 2.3 shows the typical conditions along the Hunter Street frontage of the subject site.



Source: www.google.com/maps

Figure 2.2 Hunter Street Facing West



Source: www.google.com/maps

Figure 2.3 Hunter Street Facing East

2.2.2 PITT STREET

Pitt Street is a local road managed by the City of Sydney and is situated along the eastern frontage of the site. Pitt Street is generally aligned in a north-south direction and typically comprises an approximate 11 metres wide carriageway along the site frontage, which accommodates one-way southbound traffic movements. On-street kerbside parking is available on both sides within the vicinity of the site. Various parking restrictions apply along Hunter Street including, 4P ticket, 'Loading Zone', 'Taxi Zone', and 'No Stopping'.

A 40km/h speed limit applies within the Sydney city centre, including Pitt Street. There is no existing vehicular access to the subject site from Pitt Street.

Figure 2.4 and Figure 2.5 show the typical conditions along the Pitt Street frontage of the subject site.



Source: www.google.com/maps

Figure 2.4 Pitt Street Facing North



Source: www.google.com/maps

Figure 2.5 Pitt Street Facing South

2.2.3 PITT STREET POP-UP CYCLEWAY

The recent Covid-19 pandemic has had an impact on how businesses and subsequently the CBD operate particularly with respect to traffic volumes (vehicles, pedestrians, and cyclists) within key road corridors. Subsequently, the City of Sydney, in conjunction with Transport for NSW have looked to make some changes to how the available road space is utilised. These changes have included the provision of a pop-up cycleway along Pitt Street, directly along the frontage of the site.

Based on these changes, Pitt Street now accommodates a single vehicle southbound travel lane, a kerbside parking lane on the eastern side of the carriageway, and a two-way cycle lane along the western side. A reduction in the speed limit to 30km/h has also been applied along this section of Pitt Street.

Figure 2.6 and Figure 2.7 show the modified conditions along the Pitt Street frontage of the subject site.



Source: www.google.com/maps

Figure 2.6 Pitt Street Facing North



Source: www.google.com/maps

Figure 2.7 Pitt Street Facing South

2.3 SUSTAINABLE TRANSPORT

2.3.1 PUBLIC TRANSPORT

Located within the Sydney CBD, the site has excellent accessibility to the public transport network. Table 2.1 outlines the key services that are situated within close proximity of the subject site.

Table 2.1 Public Transport Options

SERVICE	ROUTE	ROUTE DESCRIPTION	NEAREST STOP	DISTANCE FROM SITE	PEAK ARRIVAL FREQUENCY
Train	T1, T2, T3, T4, T8, T9	Various	Wynyard Railway Station	300m (4 min walk)	4-5 mins
Light Rail	L2 - Randwick Line	Randwick – Circular Quay	Wynyard Light Rail	280m (3 min walk)	8 mins
	L3 - Kingsford Line	Kingsford – Circular Quay			8 mins
Bus	X73	City Spring St – Coogee (Express Service)	Spring St before Pitt St	140m (2 min walk)	6-10 mins
	X74	City Spring St – Coogee via Alison Rd (Express Service)			12-16 mins
	X77	City Spring St – Maroubra Beach (Express Service)			10-13 mins
	X39	City Gresham St – Clovelly (Express Service)	Pitt St opp Australia Square	140m (2 min walk)	10-20 mins

2.3.1.1 TRAIN

The metropolitan train system plays a significant part in moving people around Sydney and its outer suburbs and is a practical and convenient alternative to private motor vehicle use.

The subject site is well placed to make use of the Sydney train network with Wynyard Railway Station situated an approximate 4-minute walk west of the development site. Wynyard Railway Station primarily services six train lines, which include the North Shore & Western Line (T1), the Inner West & Leppington Line (T2), the Bankstown Line (T3), the Eastern Suburbs & Illawarra Line (T4), the Airport & South Line (T8), and the Northern Line (T9).

The above train lines allow connection from all parts of the metropolitan area to the Sydney CBD.

In addition, the rail network is to introduce a new standalone railway, known as Sydney Metro with Sydney Metro West also to be located within the vicinity of the subject site. As part of the works, a new station will be developed and integrated with the existing Martin Place Station, which is an approximate 5-minute walk east of the subject site. The new station is proposed to provide a northern entrance opening to Castlereagh, Hunter and Elizabeth streets.

Given the existing train network and the proposed new rail network, the subject site location provides a convenient alternative to private motor vehicle use.

2.3.1.2 LIGHT RAIL

The CBD and South East Light Rail is a new light rail network for Sydney and runs along George Street (approximately 70m west of the subject site).

The 12km route features 19 stops, extending from Circular Quay along George Street to Central Station, through Surry Hills to Moore Park, then to Kensington and Kingsford via Anzac Parade and Randwick via Alison Road and High Street.

Sydney Light Rail plays a key role in enabling Sydney's transport future by transporting thousands of commuters between the CBD and Randwick or Kingsford in the South Eastern suburbs, and between Sydney's Inner West suburbs and Central. The light rail is a convenient alternative to private motor vehicle use.

2.3.1.3 BUS NETWORK

The subject site is well serviced for bus transport with bus express services X39, X73, X74, and X77 operating within a 2-minute walk from the subject site. Route description and the peak arrival frequency can be found for each bus route in Table 2.

The frequent services allow the bus network to be a convenient alternative to private motor vehicle use.

2.3.2 WALKING

Being within the Sydney CBD, the subject site has very good walking facilities in place with all street frontages and the surrounding streets providing a network of footpaths, which can connect pedestrians to local destinations. The majority of the footpaths are quite wide and can accommodate a large number of pedestrians. These paths allow pedestrians to connect with other sustainable transport modes such as train, light rail, and bus.

In addition, there is an existing pedestrian tunnel linking Wynyard Railway Station and Hunter Street. The tunnel will allow pedestrians with a safe and convenient accessway between the subject site and train station, whilst also reducing the number of pedestrians at street level.

Further, there are pedestrian pram crossings at all nearby intersections and pedestrian crossings at major intersections to facilitate pedestrian movements through the local area.

Thus, the method of walking to and from the site, in conjunction with the surrounding public transport options, shows that the subject site location provides a convenient alternative to private motor vehicle use.

2.3.3 CYCLING

Whilst there are no dedicated on-street bicycle lanes along the site frontages, the low speeds in the surrounding streets are conducive to a safe cycling environment.

The proposal is to include a whole basement level to accommodate bicycle parking and end-of-trip facilities, which would further encourage occupants of the building to cycle to and from the development.

2.3.4 CAR SHARE

GoGet is a service that provides car sharing vehicles. Several vehicles provided from this service is located within the vicinity of the subject site and is shown in Figure 2.8.

Car share services reduces the needs of users or businesses to own their own car by providing convenient access to a shared car on an as needs basis.

Users gain access to their booked vehicle by using the smart card provided to them on sign up. Users are able to pre-book the vehicle for collection at a designated pick up point via phone or online. When finished the vehicle is returned to the designated space.

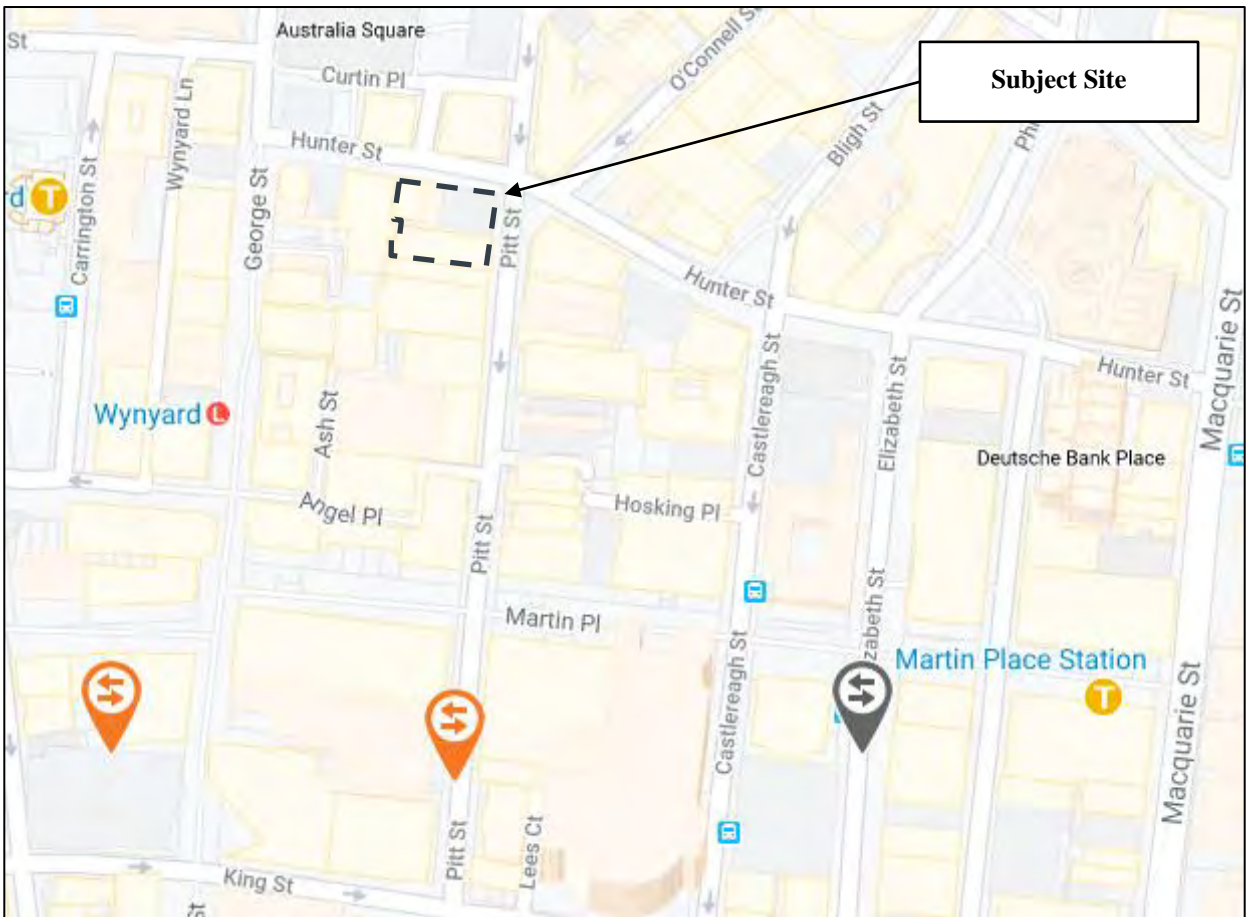

Figure 2.8 GoGet Car Share Locations

2.3.5 VEHICLE BOOKING SERVICES

Vehicle booking services such as Uber, in particular UberPool, is another form of sustainable transport, which, due to competitive pricing and ease of access, are becoming more popular as an alternate mode of transport to private motor vehicle, particularly in metropolitan locations. UberPool allows users to share their journeys with other users that are heading in the same direction, whilst also splitting the costs between the users. UberPool services the Sydney CBD area. Subsequently, the location of the site lends itself to utilising this as an alternative mode of transport.

3 PROPOSAL

The purpose of this Planning Proposal is to amend the site's Floor Space Ratio (FSR) development standard, and the Maximum Building Height to align with the Martin Place Sun Access Plane contained within the concurrent Central Sydney Planning Proposal.

An indicative reference design has been prepared Bates Smart dated March 2022 which indicates the provision of the following:

- A 51-storey commercial tower above ground level and six (6) basement levels accommodating office, retail, food and beverage, and gym use.
- A site area of 2,108sqm and a total Gross Floor Area of 52,531sqm.
- Vehicle access to the on-site car park and loading/waste collection areas via a new crossover onto Pitt Street. All onsite loading and waste collection is to be contained within a basement level, directly access from a ramp from Pitt Street (Ground Level).
- A mechanical stacker arrangement, accommodating 41 spaces accessed via two car stacker bays within the basement car park/servicing level.
- Provision of loading and waste collection with a basement level.
- Access to service vehicle parking spaces via two car lifts from the car parking/services basement level.
- A basement level accommodating End-of-Trip facilities.

A copy of the provided indicative reference design plans showing the site access and loading bay/car park access layout are included in Appendix A to this report.

4 PARKING REQUIREMENTS AND CONSIDERATIONS

4.1 CAR PARKING REQUIREMENTS

The subject site is located within the Sydney CBD and is therefore subject to the maximum parking provisions as set out within the Sydney Local Environment Plan (LEP) 2012 for an office and business development. The subject site is located on land in Category D under the Public Transport Accessibility Level (PTAL) Index.

Part 7.6 of the Sydney LEP 2012 states that the maximum number of car parking spaces for a building used for the purposes of office premises or business premises is as follows:

- a) if the building is on land in category D and has a floor space ratio of no more than 3.5:1—1 space for each 175 square metres of gross floor area of the building used for those purposes,
- b) if the building is on land in category E and has a floor space ratio of no more than 2.5:1—1 space for each 125 square metres of gross floor area of the building used for those purposes,
- c) if the building is on land in category F and has a floor space ratio of no more than 1.5:1—1 space for each 75 square metres of gross floor area of the building used for those purposes,
- d) if the building is on land in category D, E or F and has a floor space ratio greater than that specified in paragraph (a), (b) or (c) respectively, the following formula is to be used:

$$M = (G \times A) \div (50 \times T)$$

Where –

M is the maximum number of parking spaces, and

G is the gross floor area of all office premises and business premises in the building in square metres, and

A is the site area in square metres, and

T is the total gross floor area of all buildings on the site in square metres.

Similarly, Part 7.7 of the Sydney LEP 2012 states the maximum number of car parking spaces for a building used for the purposes of a retail premises. However, the Sydney LEP 2012 states that the clause does not apply to a building if the building has more than 2,000sqm of gross floor area used for the purposes of retail premises. Given the proposed development is to provide a total gross floor area greater than 2,000sqm for retail use, the clause does not apply.

Notwithstanding, for the purposes of this assessment, the proposed retail, gym, and food and beverage uses are classified as business premises.

As such, the maximum parking rates for office developments and business developments within this area are based on the gross floor area and site area of the building on the site. Based on the development plans, motor rooms, over run rooms, and transfer rooms were included as part of the gross floor area for the office and business uses, whilst the end of trip facilities was excluded.

Table 4.1 subsequently sets out the parking rate and resultant maximum allowable car parking spaces for the site.

Table 4.1 Statutory Car Parking Requirements

MAXIMUM CAR PARKING RATE	INVENTORY		MAXIMUM PARKING PROVISION
$M = (G \times A) \div (50 \times T)$	G	51,196 sqm	41 spaces
	A	2,108 sqm	
	T	52,531 sqm	

Based on the above assessment, the proposed development has a maximum allowable parking provision of 41 spaces.

The proposed development plans show the provision of 41 on-site parking spaces which complies with the maximum parking provision limits for the site.

Consideration is to be given to reducing the number of parking spaces on-site to meet the maximum provision of 41 car spaces. Noting that as the design progresses, and if the floor area changes, then the maximum parking provision is to be reassessed.

Due to the predominant office use of the proposed development, it is anticipated that all car parking spaces on-site are allocated to office staff use only. It is expected that other staff members who are not provided an on-site car parking space would be able to utilise the multitude of convenient sustainable travel modes discussed in Section 2.3 to travel to work. At a high level, it is generally considered reasonable for staff at an inner urban location to utilise off-site long-term parking or alternative travel modes to get to work.

There are a number of long-term ticketed parking facilities within close proximity to the site, particularly along Pitt Street (within approximately 100m walk from the site) which can be utilised by staff who wish to drive to work but are not allocated a car parking space. The proposed on-site provisions are therefore considered satisfactory from a staff perspective.

Given the precedence of similar sites within the area, it is reasonable to expect that visitors to the site will be aware of the need to find public parking nearby or arrange alternative transport options such as sustainable transport or taxi/Uber. The proposal of providing no additional on-site car parking for visitors is therefore considered appropriate, noting that there is opportunity for visitors to utilise public spaces on-street, and long-term ticketed parking facilities with close proximity to the site.

The following assessments within this report are based on the maximum provision of 41 car parking spaces within the site.

4.2 ACCESSIBLE CAR PARKING SPACES

Schedule 7.8.5 of the Sydney DCP 2012 requires one space for every 20 car parking spaces or path thereof is to be allocated as accessible visitor parking. Given, all on-site car parking spaces are to be allocated to staff use only, this clause is not applicable.

Notwithstanding, for the purposes of providing accessible parking for staff with disabilities, this assessment has given consideration the above rate. On this basis, and assuming the maximum provision of 41 car parking spaces will be provided, there would be a need to accommodate three (3) accessible parking spaces.

A review of the development plans show that the car stacker bays provide adequate clearances to be used for accessible use, with the bays being afforded additional width to further improve DDA accessibility. Given the automated use of the mechanical car parking arrangement, drivers with disabilities would not need to manually park within a mechanical stacker, and thus there is no difference between accessible and conventional spaces with respect to the parking provision and as such it is considered that the requirement for three (3) DDA spaces is met.

It is recommended however that a DDA / Disability Access Consultant confirm the arrangement is appropriate.

4.3 CAR SHARE CONSIDERATIONS

In addition to setting out the maximum car parking provision, Section 3.11.2 of the Sydney DCP 2012 outlines car share parking provision requirements for developments that provide parking spaces for exclusive use by an organised car share scheme (car share parking spaces).

Given the development is proposed to not provide parking spaces for an exclusive use by an organised car share scheme, this requirement is not applicable to the development.

4.4 MOTORCYCLE PARKING REQUIREMENTS

Schedule 7.8.4 of the Sydney DCP 2012 requires that in all buildings that provide on-site parking, 1 motorcycle parking space for every 12 car parking spaces is to be provided as separate parking for motorcycles.

It is assumed that the maximum provision of 41 car spaces will be provided. Based on the above rate, the proposed development with a provision of 41 spaces would have a requirement to provide a minimum of 3 motorcycle parking spaces.

The development plans do not currently show the provision of any motorcycle parking spaces, however it is considered that there is likely sufficient space within basement 1 to allow for the provision of the required motorcycle parking.

4.5 BICYCLE PARKING REQUIREMENTS

Section 3.11.3 of the Sydney DCP 2012 specifies the bicycle parking requirements for various uses. As per Table 3.5 to Section 3 of the Sydney DCP 2012, the bicycle parking requirements for the proposed development are set out within Table 4.2 below. A gym is not listed within Table 3.5 to Section 3 of the Sydney DCP 2012.

Table 4.2 Statutory Bicycle Parking Requirements

USE	AREA	EMPLOYEE RATE	EMPLOYEE REQUIREMENT	VISITOR RATE	VISITOR REQUIREMENT
Office	41,790 sqm	1 per 150 sqm GFA	279 spaces	1 per 400 sqm GFA	104 spaces
Shop, Restaurant or Café	5,465 sqm	1 per 250 sqm area	22 spaces	2 plus 1 per 100 sqm over 100 sqm GFA	57 spaces
Total			301 spaces		161 spaces

Based on the above assessment, Table 4.2 shows the proposed development has a requirement to provide 462 bicycle spaces comprising 301 staff spaces and 161 visitor spaces. It is however noted that given the location of the site within the Sydney CBD, and the proximity to convenient public transport options, bike parking demands may actually be lower than the noted statutory provision rate. Further investigations during design development may therefore be warranted to assess the likely site demands and any reduction being sought.

In conjunction with the statutory provision requirements, the Australian Standards AS2890.3:2015 also requires that 20% of bicycle parking is provided within an at-grade horizontal arrangement. Should the statutory requirement be provided, then, at least 95 bicycle spaces must therefore be provided within a horizontal parking arrangement.

Further, Section 3.11.3 of the Sydney DCP 2012 specifies that where bike parking for tenants is provided in a basement, it is to be located on the uppermost level of the basement, and that bike parking for visitors is to be provided in an accessible on-grade location near a major public entrance to the development.

It is noted that whilst current plans do not indicate the exact number of bicycle parking spaces provided for the development, plans do show Basement 5 being allocated for Bicycle Storage and End-of-Trip purposes. Typical horizontal bike parking spaces have floor area requirement of 0.9 sqm per space, whilst vertical hanging spaces can be accommodated within a footprint of approximately 0.6 sqm. In conjunction with this, access aisle requirements of 0.75sqm per space are also typical for bike parking. Based on the statutory provisions in conjunction with the AS2890 requirements, it could therefore be anticipated that these rates would require provision of approximately 750sqm floor area for bike parking.

On this basis it is considered that the 1,549 sqm GFA footprint of Basement 5 should provide sufficient space to accommodate the bike needs of the site. Further investigation may need to be undertaken based on the specific bike parking systems proposed to be used.

4.6 END-OF-TRIP FACILITIES

In addition to the above parking provision requirements, Section 3.11.3 of the Sydney DCP 2012 also requires the provision of lockers and shower and change facilities for non-residential uses. The rates for these facilities are listed as follows:

- 1 personal locker for each bike parking space;
- 1 shower and change cubicle for up to 10 bicycle spaces;
- 2 shower and change cubicles for 11 to 20 or more bike parking spaces;
- 2 additional showers and cubicles for each additional 20 bike parking spaces or part thereof;

For the purposes of this assessment, it is expected that end-of-trip facilities are to be used by employees only. Thus, based on the minimum provision of 322 bicycle parking spaces for employees, there is a requirement to provide 322 lockers and 18 shower and change cubicles. End-of-trip facilities are to be located close to the bike parking area.

It is considered that the Basement Level 5 footprint should be able to provide capacity to accommodate these provisions.

4.7 SERVICE VEHICLES

Schedule 7.8.1 of the Sydney DCP 2012 requires separate on-site parking spaces for service vehicles. The rate of which service vehicle parking spaces should be provided for commercial premises are summarised as follows:

- 1 space per 3,300sqm GFA, or part thereof, for the first 50,000 sqm; plus
- 1 space per 6,600sqm, or part thereof, for additional floor area over 50,000 sqm and under 100,000 sqm; plus
- 1 space per 13,200 sqm, or part thereof, for additional floor area over 100,000 sqm

Based on the preceding, for the proposed development which has a total Gross Floor Area (GFA) of 52,531sqm, there is a requirement to provide 16 parking spaces for service vehicles.

The development plans show the provision of three (3) service bays situated within Basement Level 1, with a further 13 service bays on Basement Level 2. Subsequently, the development will see the overall provision of 16 service bays, in line with statutory requirements.

In the context of the proposal, with the site primarily being of an office nature, it is considered that these spaces would be able to be managed, such that any loading/unloading activities will occur at different times, and that all deliveries and services will operate on a timed schedule to manage the number of vehicles within the loading area at any one time.

As the development progresses or when the building is within operation, a Service Delivery Plan or Loading Management Plan (or similar), is to be prepared to manage and co-ordinate service vehicles on-site. In addition to the management plan, the Body Corporate (or equivalent) should implement a loading area manager to further assist with the daily operations of the loading area.

5 TRAFFIC GENERATION AND IMPACTS

5.1 ESTIMATED SITE GENERATED TRAFFIC

Due to the predominant office use of the proposed development, it is anticipated that all car parking spaces on-site are allocated to office staff use only. As such, for the purposes of this assessment, it is conservatively assumed that traffic generated during the peak commuter periods is in line with an office use.

The below assessment reviews two scenarios in which traffic may be generated by the site. These include a ‘worst case’ scenario using an empirical assessment and a ‘more realistic’ scenario based on case study data.

5.1.1 EMPIRICAL ASSESSMENT

Based on a total maximum on-site parking provision of 41 spaces, it is conservatively estimated that the development could generate:

- Up to 41 vehicle movements during each of the AM and PM peak commuter periods when employees generally arrive to work and then later return.
 - In which there would generally be up to 90% inbound movements and 10% outbound movements during the AM peak commuter period. This is to factor in employees who may leave the site during the AM peak for meetings or other work-related tasks.
 - In which there would generally be up to 90% outbound movements and 10% inbound movements during the PM peak commuter period. This is to factor in employees who are returning to the office during the PM peak.

5.1.2 CASE STUDY DATA ASSESSMENT

The RTA Guide to Traffic Generating Developments 2002 lists traffic generation rates for various uses. The RMS then published a Technical Direction document in August 2013, which is a complementary document to the RTA Guide providing updated survey data and traffic generation rates. In assessing the anticipated traffic generation for the proposed uses, the following rates listed in the Technical Direction document have been adopted:

- For office blocks similar to the site (North Sydney), a rate of 52 vehicle trips per 136 car parking spaces in the AM peak, equating to 0.38 vehicle trips per 1 car parking space in the AM peak;
- For office blocks similar to the site (North Sydney), a rate of 44 vehicle trips per 136 car parking spaces in the PM peak, equating to 0.32 vehicle trips per 1 car parking space.

It is noted that the RTA Guide defines a vehicle trip as a one-way vehicular movement from one point to another excluding the return journey.

Therefore, based on the above rates and a total on-site parking provision of 41 car parking spaces, the development is anticipated to generate 16 vehicle trips during the AM peak and 13 vehicle trips during the PM peak. These movements would typically follow the same AM and PM directional splits as noted in Section 5.1.1 prior.

5.2 TRAFFIC IMPACTS

The level of traffic expected to be generated by the development in both scenarios is considered low and would have a minimal impact on the operation of Pitt Street and the surrounding road network.

In the event of a ‘worst case’ scenario, 41 vehicle movements during each of the AM and PM peak periods equates to less than 1 movement every 1 to 2 minutes during the peak periods. This is further reduced based on case study data provided by RMS, in which 16 trips during the AM peak equates to less than 1 trip every 3 to 4 minutes.

This number of movements is considered low from a traffic engineering context and is likely well within the range of standard daily traffic variations on the surrounding road network. Subsequently, traffic as generated by the site is anticipated to be adequately accommodated within the wider surrounding CBD road network.

5.2.1 SINGLE ACCESS LANE

Access to the onsite car parking and loading areas is proposed via the provision of a single width ramp extending down from the ground level site access on Pitt Street into Basement Level 1. This ramp is to accommodate passing areas both at the top and bottom, and is to comprise a single width section for approximately 40m. Movements along the ramp will be controlled via the use of a traffic management system installed at the top and bottom.

Based on an assessment of the critical AM and PM peak periods (both of which accommodate traffic flows that are largely tidal in nature), it is estimated that the chance of 2 opposing vehicles requiring the use of the ramp at the same time would be in the order of 0.1% of the peak hour. On this basis it is considered that the provision of a single passing space at the top and bottom of the ramp should be sufficient for operation.

5.2.2 CAR STACKER QUEUE ANALYSIS

One of the other possible impacts associated with the projected traffic volumes and the proposed onsite parking arrangements within a car stacker system is the potential for vehicle queuing and how this is to be accommodated onsite.

Subsequently, WSP have undertaken a queue analysis for the site based on the peak AM traffic volumes which is considered to be the critical period as, given the site use, it is during this period that the greatest number of inbound movements are expected to be generated. Key inputs that have therefore been included in this analysis are:

- 16 vehicle trips during the AM peak.
- The proposed car stackers (detailed in Section 6.4) can conservatively operate at a rate of 18 cycles per hour (3-minute turnaround times). Total allowance for 36 cycles per hour across the 2 stacker bays.

Based on these inputs, the analysis shows that the anticipated 98th percentile queue length for the site during the AM peak would be for four (4) waiting vehicles. The development plans show the provision of four (4) waiting bays within Basement Level 1 prior to the car stackers, with further queuing capacity also accommodated at ground level at the entrance to the site, thereby adequately accommodating this demand.

5.2.3 SERVICE VEHICLE LIFT

In addition to the car stackers, the development plans also show the provision of two (2) car lifts providing service vehicle access from Basement Level 1 to the additional service/loading spaces on Basement Level 2. It is understood that these car lifts can typically operate at a rate of 0.15m/s, which on the basis of approximately 4.0m floor to floor between basement levels, would suggest a single directional trip would take in the order of 45 seconds (including allowance for vehicles to enter and exit the lift).

On this basis, it is considered that the two (2) car lifts would be able to undertake up to 80 complete circulations (B1 to B2 to B1) per hour. Given only 13 service vehicle spaces within Basement Level 2, and that all service vehicle movements are to occur outside of peak hours and be subject to a Loading Management Plan, it is therefore considered that these car lifts will adequately service loading/service vehicle access to and from Basement Level 2.

6 DESIGN CONSIDERATIONS

6.1 SITE ACCESS AND CIRCULATION

Development plans show that vehicle access to the subject site is proposed via the provision of a new two-way access onto Pitt Street in the site's south-east corner. This access will connect to an internal ramp, providing a connection down to Basement Level 1 which accommodates three (3) loading bays, the car stacker access, and the service vehicle lifts. Given the existing one-way arrangement on Pitt Street, all vehicle movements at the site access will be inbound from the north, and outbound to the south.

Swept path diagrams have been prepared confirming the site circulation arrangements using both a B99 design vehicle (car/van) and also a 6.4m Small Rigid Vehicle (SRV) from AS2890, and are attached in Appendix B. The diagrams confirm that both the B99 vehicle and SRV can adequately enter the waiting bay at the top of the ramp whilst another vehicle departs, and then circulate down within the sites to either the loading bays, car stacker, or car lift.

The diagrams have also been prepared showing the relevant vehicles accessing each of the loading bays, car stackers, and vehicle lifts on Basement Level 1. For the car stackers, the diagrams confirm that from the queuing spaces, vehicles will be able to adequately enter the bays in a forward's direction. On departing the stacker, vehicles will be positioned such that they can depart in a forward's direction.

For the loading bays and service lifts, it is envisaged that access to these spaces will be under the supervision of a loading area attendant with all movements being reverse in, such that departure movements are in a forward's direction. This also applies to the loading spaces on Basement Level 2.

The diagrams confirm that all assessed vehicles will be able to adequately enter and exit the site in a forward's direction along with accessing their required locations onsite. On this basis, the proposed access/egress for car park lifts and site access/egress is considered satisfactory.

6.2 RAMP GRADES

Access to the basement car park and loading area is proposed via the provision of a single width ramp from the Pitt Street access down to Basement Level 1.

Initially, from the Pitt Street crossover, this ramp is to extend up into the site to a crest via a combination of 1:20 and 1:8 grade transitions, generally in line with the design requirements of AS2890. From the crest, the ramp is to extend down into the site via a combination of 1:20 and 1:8 grade transitions, before reaching a maximum grade of 1:6.5 for the majority of its length. Grade transitions of 1:8 and 1:20 then assist the ramp in leveling out to the Basement Level 1 floor. A minimum headroom clearance of 3.8m is provided along the ramp.

The grade transitions and maximum grades as shown generally align with those as specified within AS2890 for vehicles up to the size of a 6.4m SRV along with the minimum headroom clearances provided.

Vertical clearance and ramp grade diagrams have been prepared for the ramp and have been assessed for use with the 6.4m SRV from AS2890. These diagrams are included within Appendix B to this report and confirm that the ramp grades, transitions, and headroom clearances are suitable for use by vehicles up to the size of a 6.4m SRV.

On this basis, the above ramp grades are considered appropriate for the intended use of the site.

6.3 CAR PARKING DESIGN

Development plans show that 41 car parking spaces are to be provided on-site within a mechanical car stacker system on Basement Level 6. It is suggested that three (3) of these spaces are to be allocated for those with disabilities.

The mechanical car stacker system is accessed via the proposed car stacker bays on Basement Level 1. Drivers are to park their vehicle within the bay, exit the vehicle, and operate the lift controls which will be located external to the lifts. The cars would then be transported to Basement Level 6 where the mechanical system automatically parks the vehicle. It is assumed that the mechanical parking system will allow for all vehicles to enter the parking bay in a forwards direction, and then manoeuvre the car within the system, such that a departing vehicle can then also exit in a forwards direction.

Given the automated use of the mechanical car parking arrangement, drivers with disabilities would not need to manually park within a mechanical stacker, and thus allocating three (3) disabled parking spaces within a mechanical arrangement would be considered appropriate. However, a DDA / Disability Access Consultant should confirm this arrangement is appropriate.

Further to the above, and in accordance with the Australian Standards AS2890.6, a headroom clearance of 2.5m should be provided above the disabled spaces. To accommodate this, it is considered that the 2.5m headroom clearance could be incorporated into the car stacker bays.

Subject to the above, the car parking spaces have therefore been designed in accordance with the relevant standards and are considered satisfactory for the proposed development.

6.4 MECHANICAL PARKING

As mentioned previously, it is proposed for 41 car parking spaces to be accommodated within car stackers and allocated to staff use only. Based on a review of the architectural plans, the following or similar car stacker is to be accommodated:

- WOHR Multiparker 730 Shuttle/Lift -System (or similar) – 41 Spaces.

The proposed WOHR Multiparker 730 car stacker system will provide an automatically operated parking system, which is customisable to suit individual project requirements, including the arrangement of the lifts and transfer areas. The system allows for a fast access time by the use of a quick-change pallet system, which runs independently and simultaneously on each level between parking spaces and the car lifts. Data sheets for the above car stacker system are attached in Appendix C.

For improved accessibility within the site, it is recommended that as part of the mechanical parking system, internal rotating of vehicles is to be allowed for such that all vehicles enter and exit the car lifts in a forward direction.

Based on the architectural plans, the stacker system is to accommodate two levels of car parking. As the design progresses, consultation with the manufacturer/supplier is required to confirm all spatial requirements.

On this basis, given the mechanical system is customisable to suit individual project requirements, the proposed mechanical parking is therefore considered satisfactory.

6.5 CAR LIFT

In addition to the above noted mechanical parking, the development plans also show the use of two (2) car lifts to provide service vehicle access between basements 1 and 2. Data sheets for a car lift system that could be considered are attached in Appendix C.

In order to ensure that all vehicles can depart from the lifts in a forward's direction, all vehicles will be required to reverse into the lifts both at Basement Level 1 and 2. It is understood that these lifts will only be for service/loading vehicle use, with all movements under the control of a Loading Management Plan. On this basis, the proposed car lift arrangements are considered appropriate given the nature of the development.

6.6 LOADING AND WASTE COLLECTION

On-site loading and waste collections are to be facilitated within Basement Level 1 and 2 with ingress and egress via the site access onto Pitt Street. The development plans show the provision of three (3) dedicated bays in Basement Level 1, with a further 13 bays in Basement Level 2.

On Basement Level 1, two (2) of the bays are to have dimensions of 3.5m width by 7.6m length and are design for use by larger vehicles (i.e. 6.4m SRV) and waste collection vehicles. The other space on this level is to be targeted towards couriers and vans and as such is to have dimensions of 2.6m width by 5.4m length. In Basement Level 2, all the bays are to be targeted towards vans and couriers and are to have dimensions of 2.4m width by 5.4m length.

Based on discussions with the project team, the largest vehicle to enter the site will be a waste collection vehicle. It is understood that this will be in the form of a 6.4m small waste collection truck, which has operational specifications less than that of a standard SRV. On that basis it is considered that the waste collection vehicles will be able to adequately access the providing loading spaces within the site. This is confirmed by the swept path diagrams that have been prepared and are attached in Appendix B.

It is noted that as the design progresses, and if a larger vehicle is required for loading and/or waste collections, then the basement level loading area is to be reassessed and the appropriate headroom clearances for the vehicle is to be provided.

Given that the loading bay is accessed from the same entry point as the car park, all loading and waste collection movements will need to be undertaken under controlled conditions, outside of peak hours.

On this basis, the proposed loading bay arrangements are therefore considered appropriate for the proposal given the nature of the development.

7 CONCLUSION

The purpose of this Planning Proposal is to amend the site's Floor Space Ratio (FSR) development standard, and the Maximum Building Height to align with the Martin Place Sun Access Plane contained within the concurrent Central Sydney Planning Proposal.

An indicative reference design has been prepared Bates Smart dated March 2022 which indicates the provision of the following:

- A 51-storey commercial tower above ground level and five basement levels accommodating office, retail, food and beverage, and gym use.
- A site area of 2,108sqm and a total Gross Floor Area of 54,288sqm.
- A basement parking level accommodating 41 car parking spaces within a mechanical stacker arrangement, accessed via two car bays from Basement Level 1.
- Vehicle access to the on-site car park and loading/waste collection areas via a new a new crossover and access onto Pitt Street.

Having consideration for the preceding analysis it is concluded that:

- Consideration is to be given to allocating three (3) car spaces within the automated mechanical parking system to disabled parking use. It is recommended that a DDA Disability Access Consultant confirm the arrangement is appropriate.
- Initial calculations estimate that there will be adequate space onsite to accommodate the bicycle parking demands and end of trip facilities. Design development plans are to show bicycle parking and end-of-trip facilities, including 495 bicycle spaces comprising of 329 staff spaces and 166 visitor spaces, 329 lockers, and 18 shower and change cubicles. End-of-trip facilities are to be located close to the bike parking area.
- Consideration is to be given to providing staff bicycle parking on the uppermost level of the basement, and visitor bicycle parking in an accessible on-grade location near a major public entrance to the development.
- Consideration should be given to preparing a Service Delivery Plan or Loading Management Plan, to manage and co-ordinate service vehicles on-site. In addition to the management plan, the Body Corporate (or equivalent) should implement a loading area manager to further assist with the daily operations of the loading area.
- Traffic as generated by the site is anticipated to be adequately accommodated within the wider surrounding CBD road network.
- The availability of convenient alternative sustainable travel modes surrounding the site shows that the subject site location provides a convenient alternative to private motor vehicle use.
- Queue analysis for the proposed car stacker arrangements indicates that during the AM peak period, the 98th percentile queue should be sufficiently accommodated within the four (4) proposed onsite queuing spaces.
- It is recommended that the mechanical parking system provided allows for vehicles to enter the car lifts in a forward direction and exit the car lifts in a forward direction. This would be achieved via a turntable within the mechanical systems.
- It is noted that as the design progresses, and if a larger vehicle is required for loading and/or waste collections, then the ground level loading area is to be reassessed and the appropriate headroom clearances for the vehicle is to be provided.
- Swept path diagrams attached in Appendix B show that a vehicle up to the size of a 6.4m SRV can adequately access and circulate through the onsite loading facilities.

Based on the preceding assessment and subject to the above considerations, the proposed commercial development is considered appropriate from a traffic engineering perspective given the location of the site and nature of the development.

APPENDIX A

DEVELOPMENT PLANS



Reference Design Drawing Set

INDICATIVE SECTION

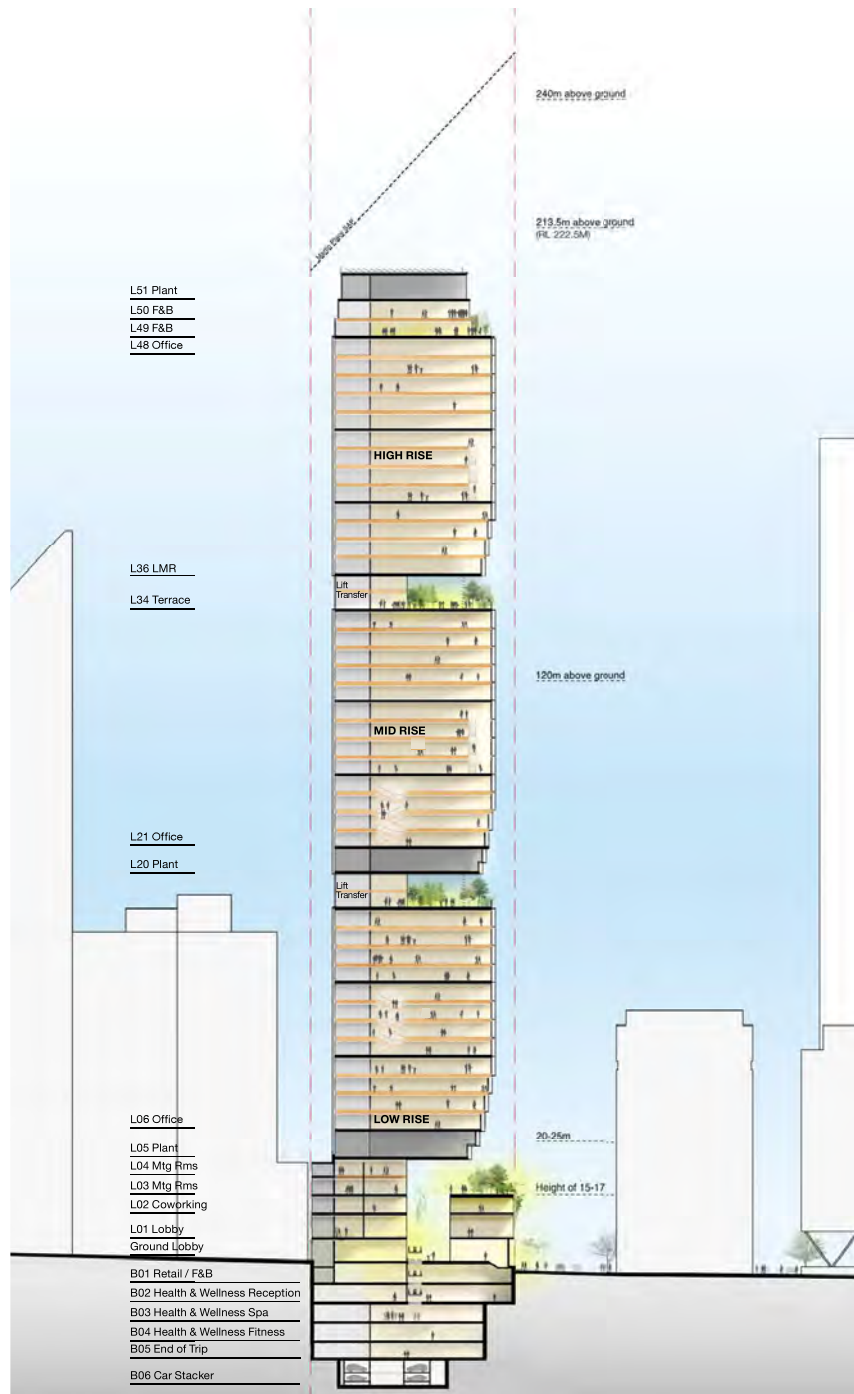

1:1000 @ A3

BASEMENT 06

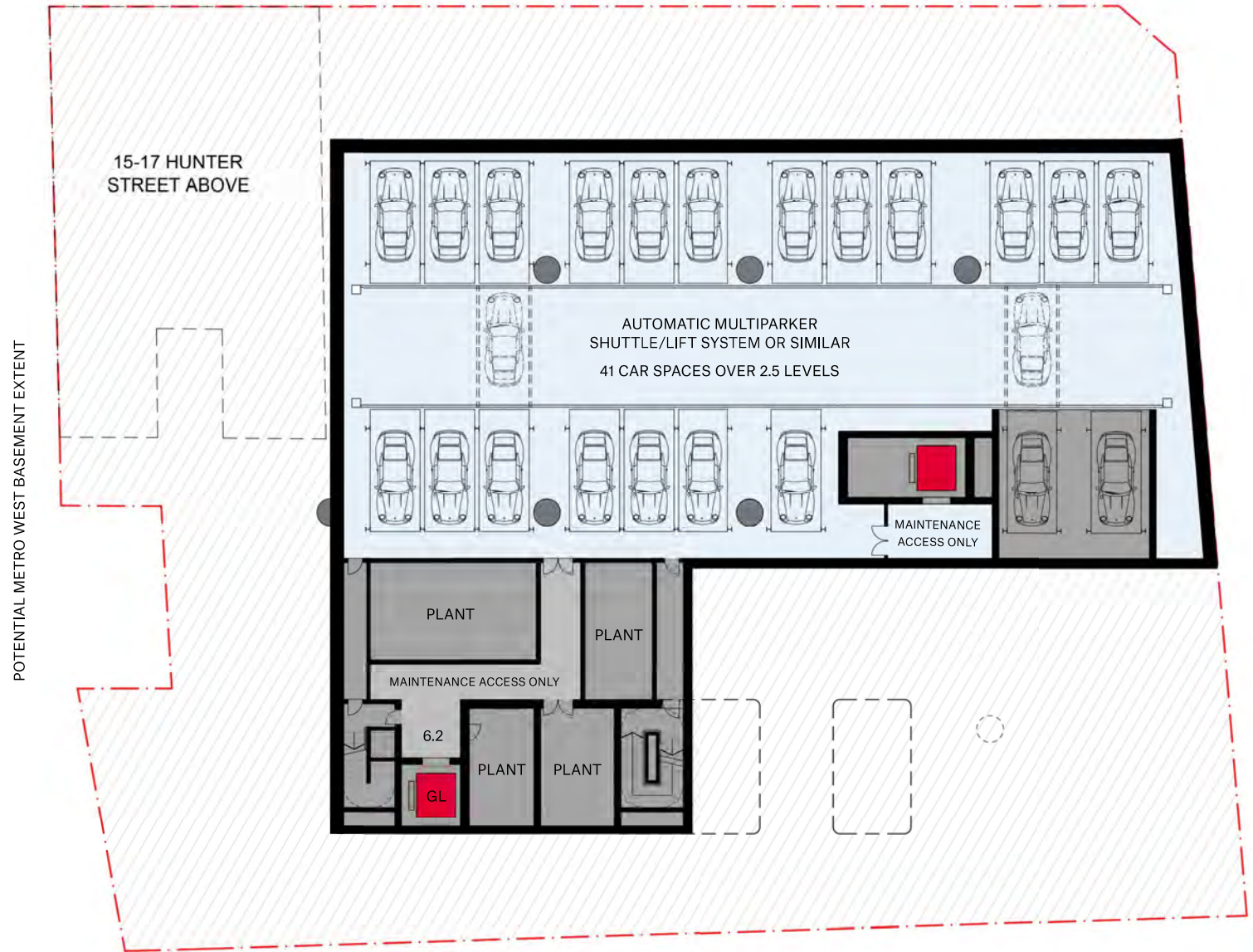

1:200 @ A3



BASEMENT 05

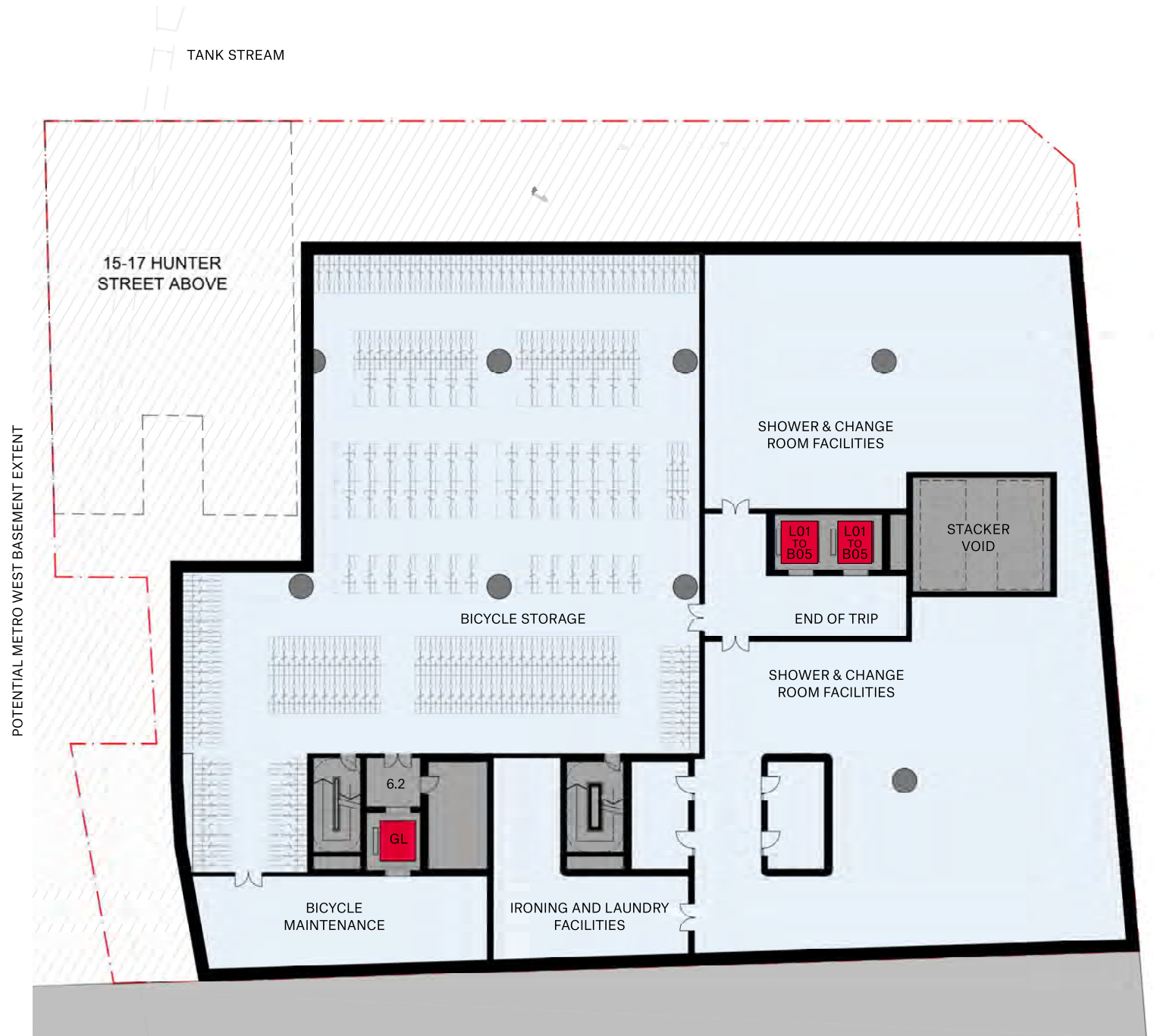

1:200 @ A3



BASEMENT 04

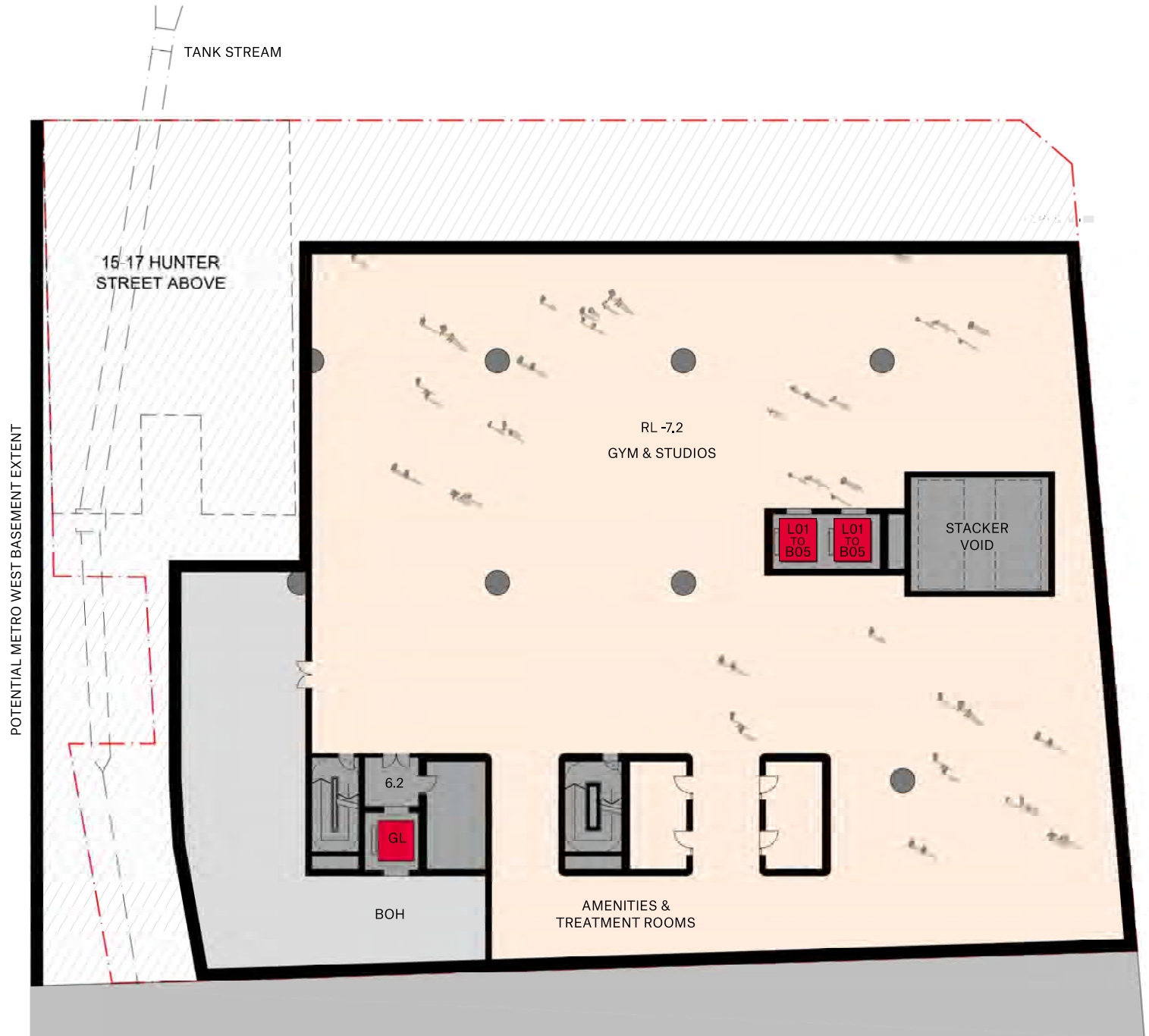

1:200 @ A3



BASEMENT 03

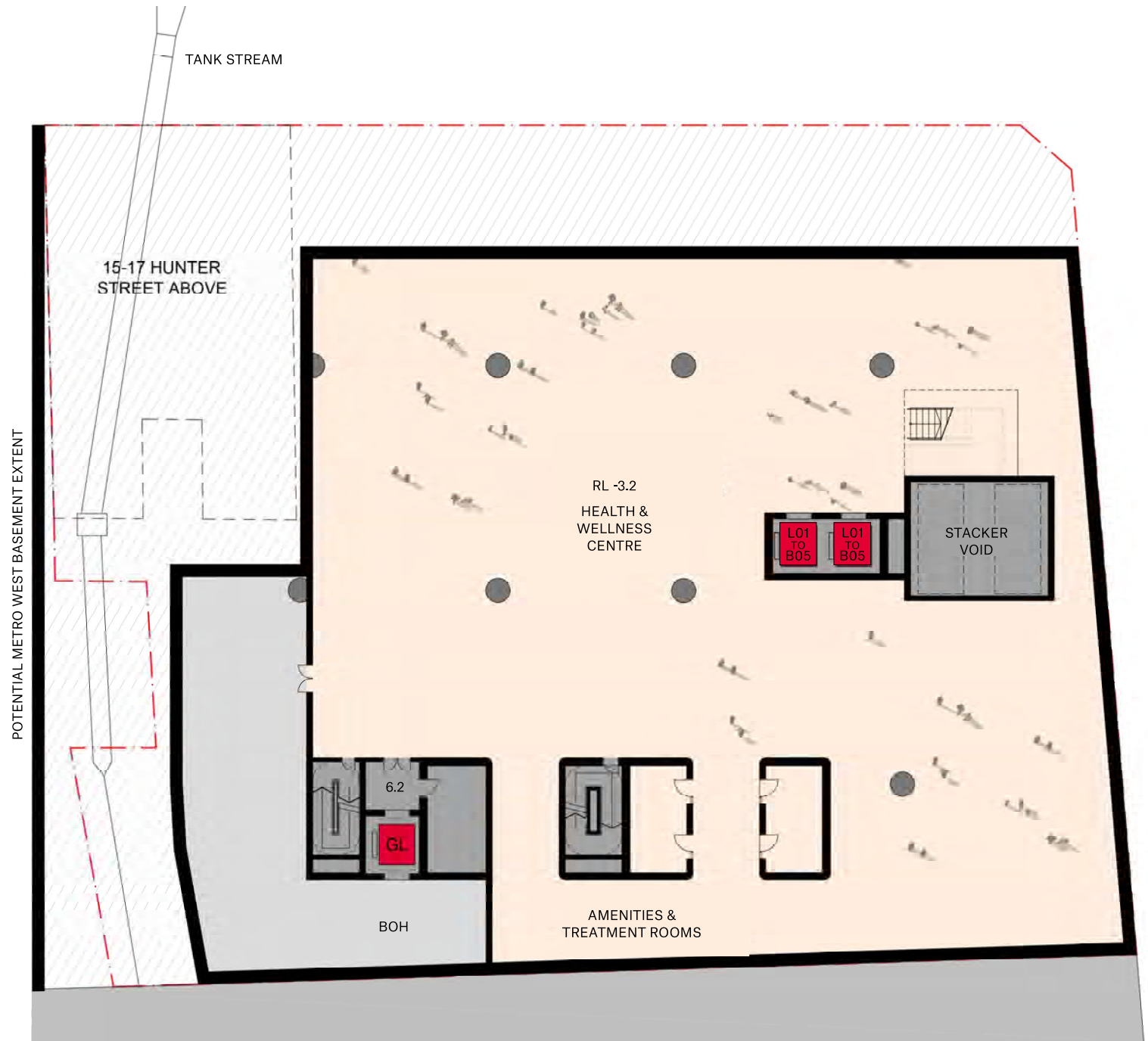

1:200 @ A3

BASEMENT 02

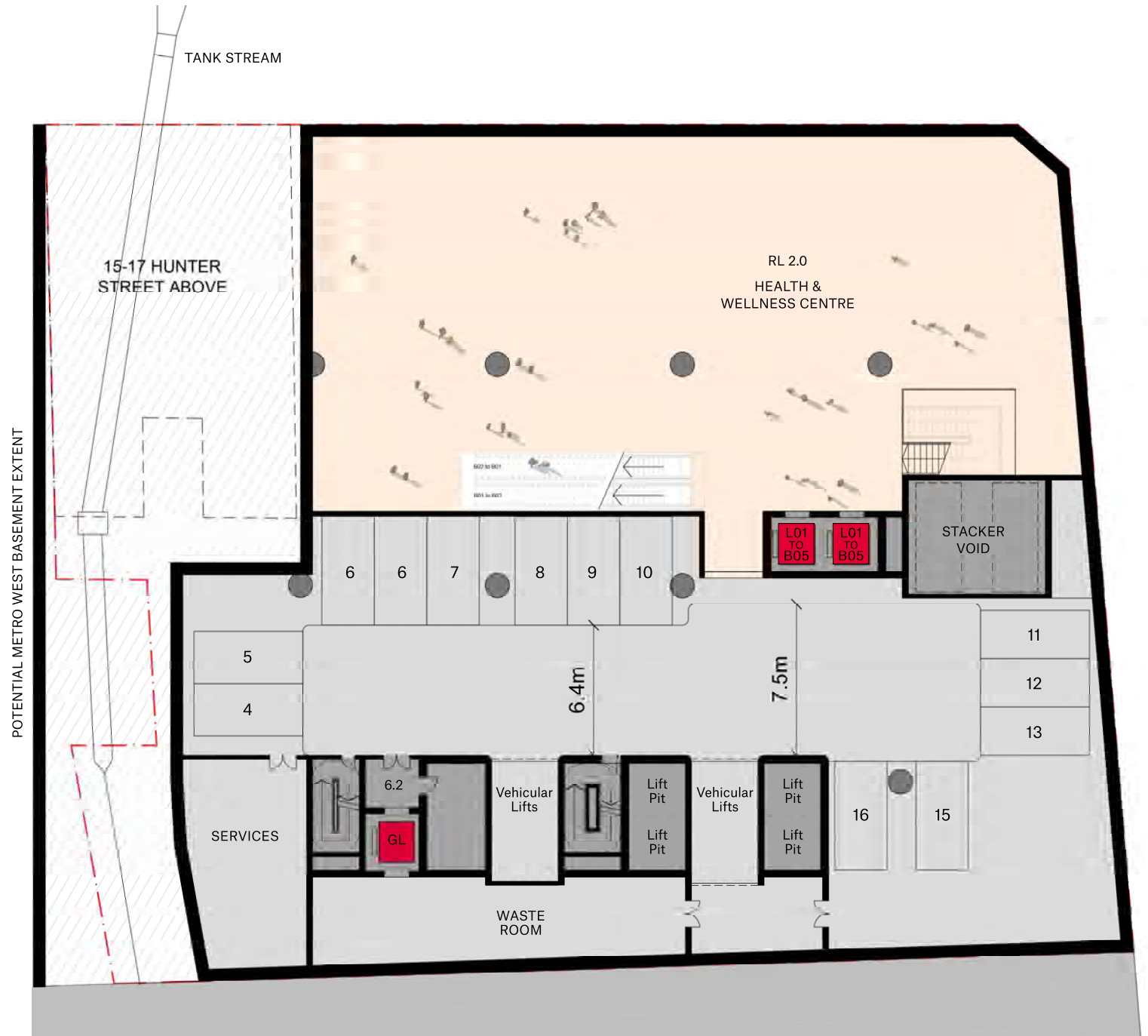

1:200 @ A3

BASEMENT 01

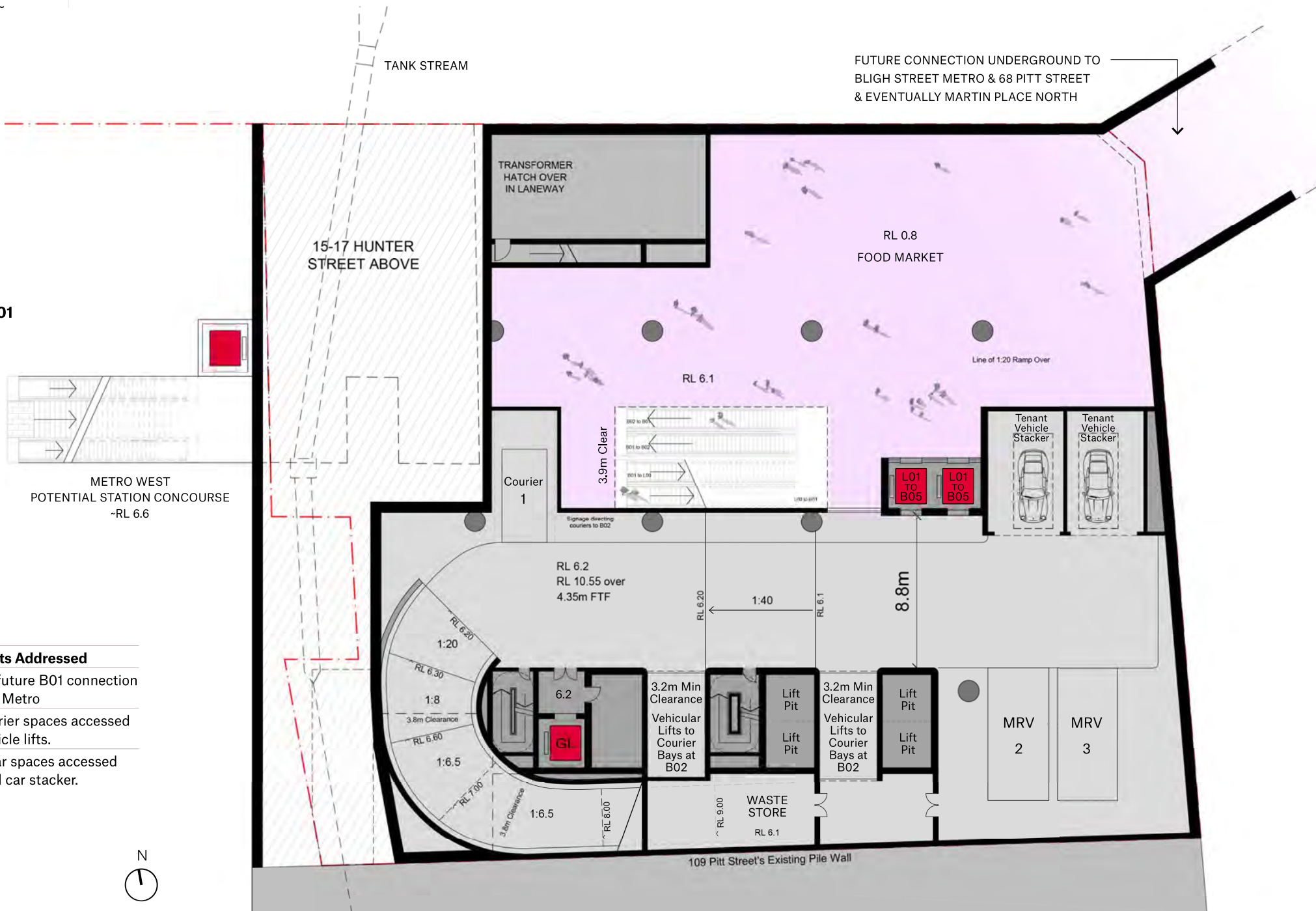

METRO WEST
POTENTIAL STATION CONCOURSE
-RL 6.6

DAP Comments Addressed

- Allowance for future B01 connection to Bligh Street Metro
- Additional courier spaces accessed via courier vehicle lifts.
- Commercial car spaces accessed via commercial car stacker.



1:200 @ A3

LEVEL 01

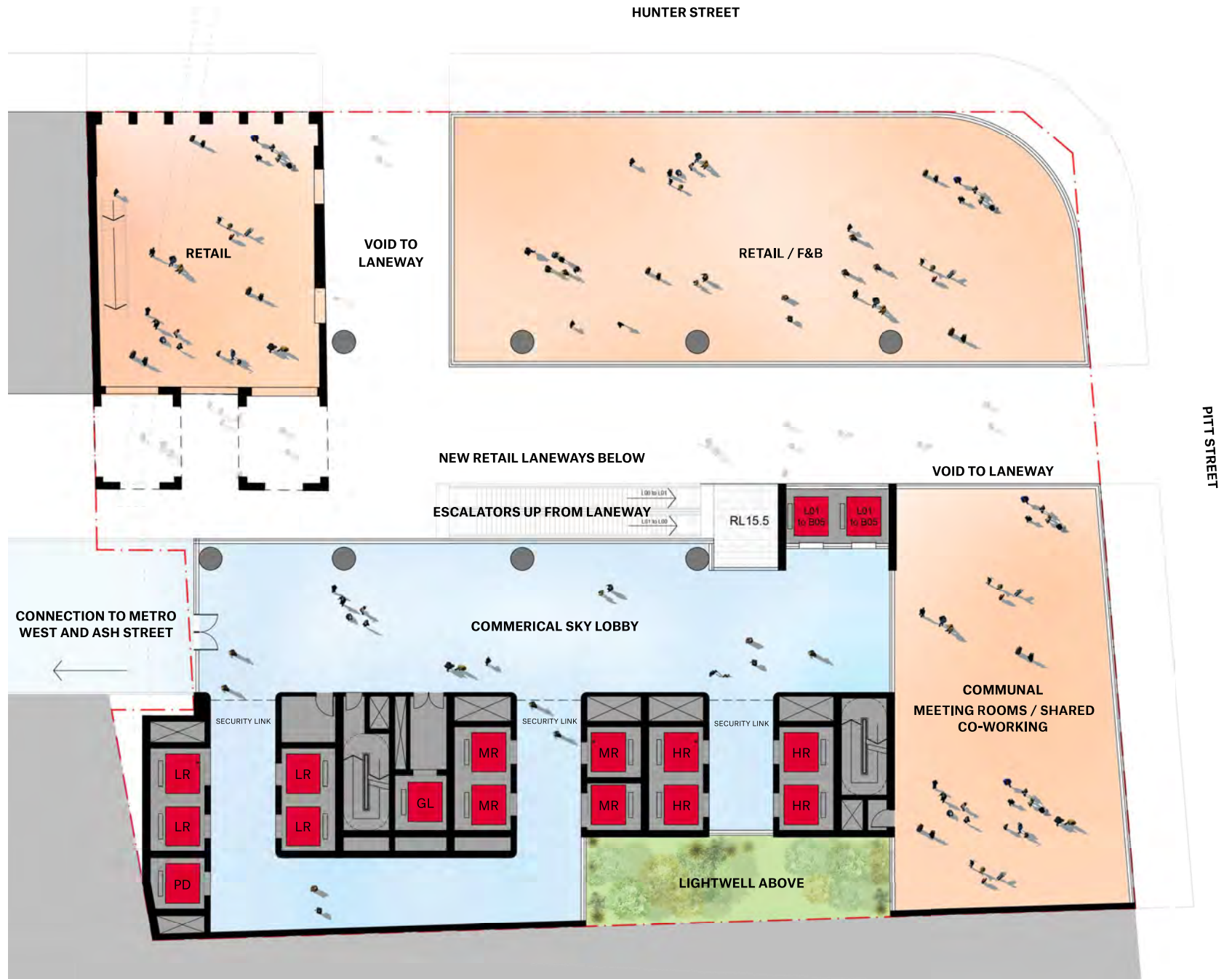

1:200 @ A3

HUNTER STREET

LEVEL 02



PITT STREET

1:200 @ A3

HUNTER STREET

LEVEL 03
Hunter Street Podium
Landscaped Terraces



1:200 @ A3

HUNTER STREET

LEVEL 04

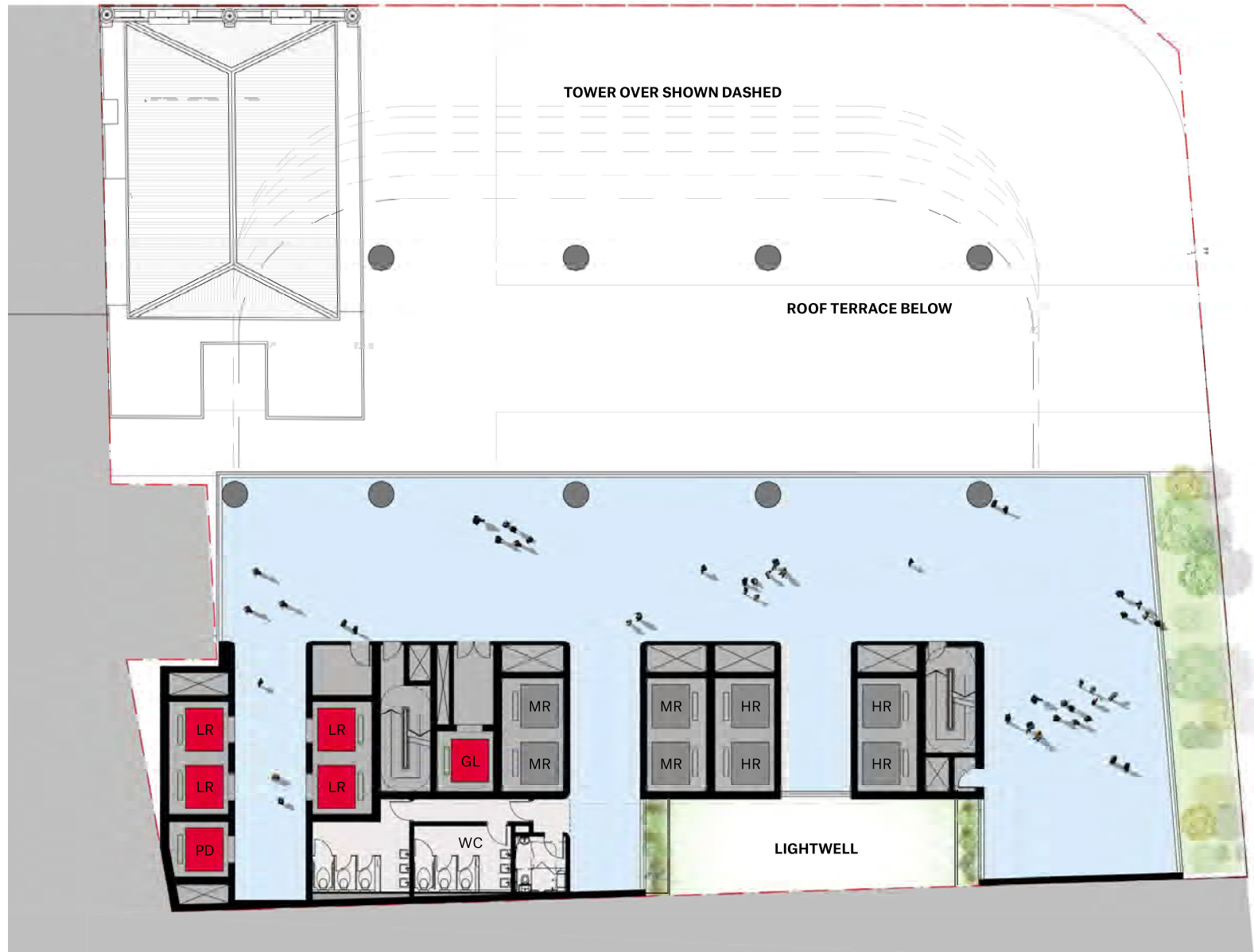

PITT STREET

1:200 @ A3



HUNTER STREET

LEVEL 05 PLANT

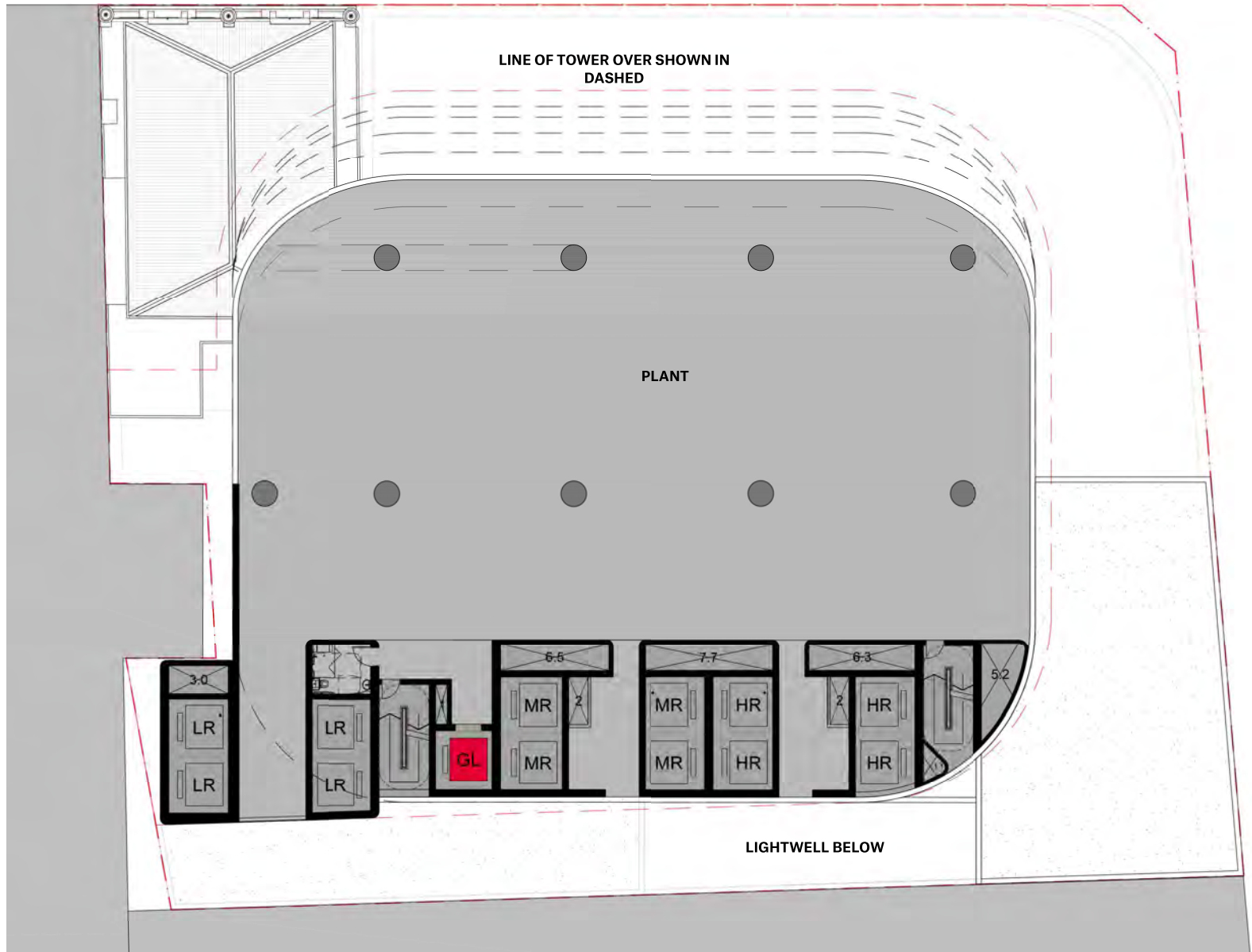

PITT STREET

1:200 @ A3



LOW RISE

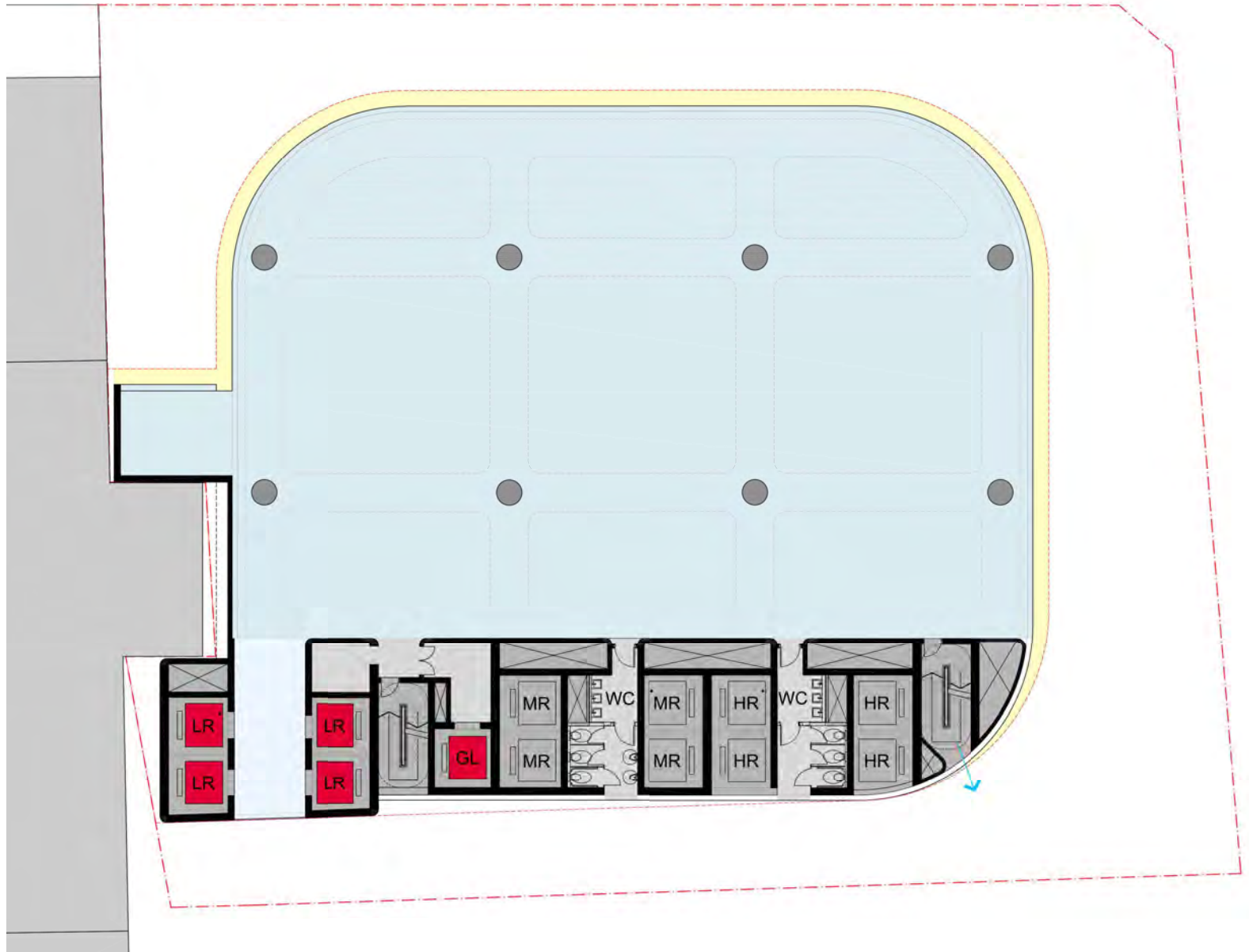

1:200 @ A3

LEVEL 18 LIFT TRANSFER

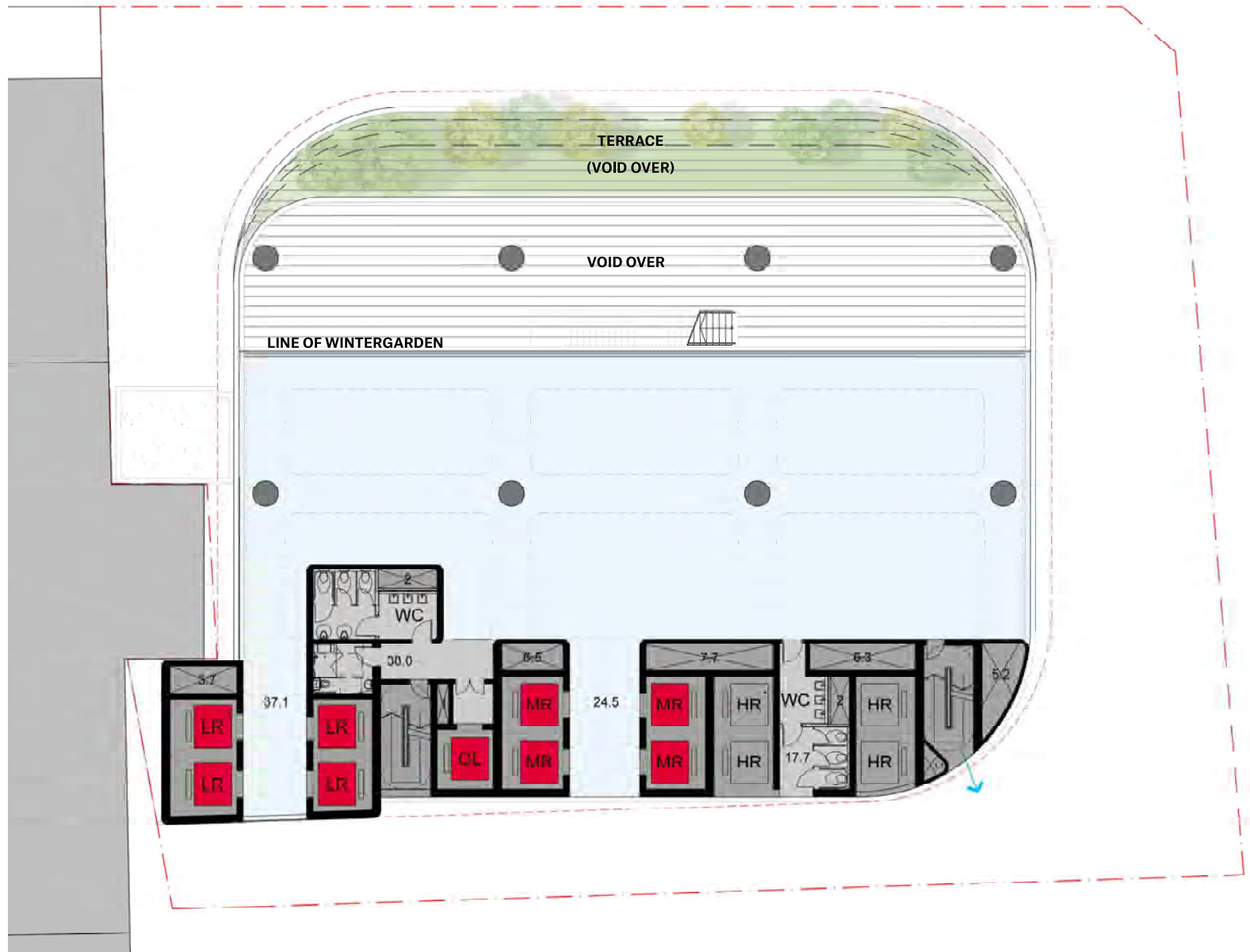

1:200 @ A3

**LEVEL 19 TERRACE
& WINTERGARDEN VOID**

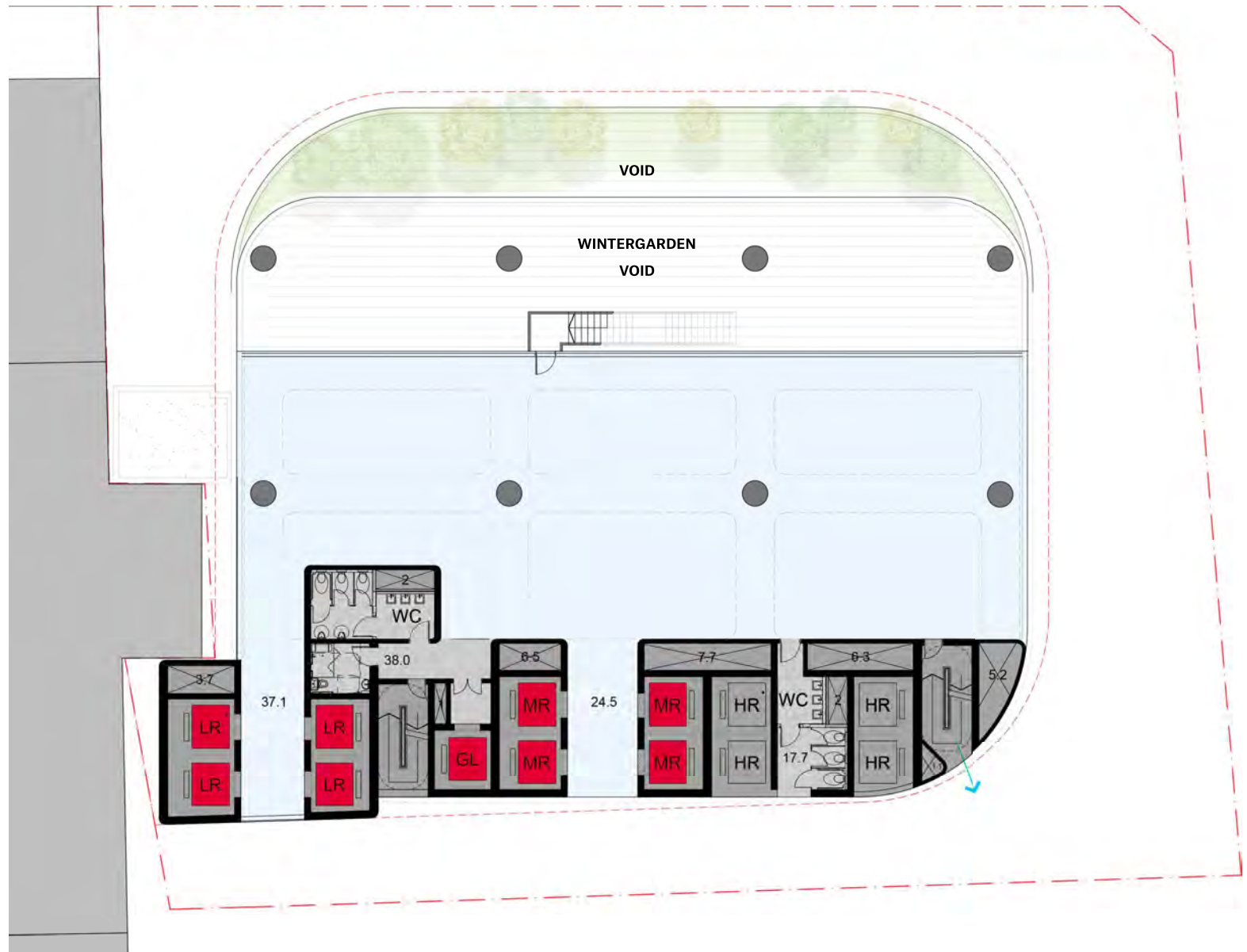

1:200 @ A3

LEVEL 20 LOW RISE PLANT

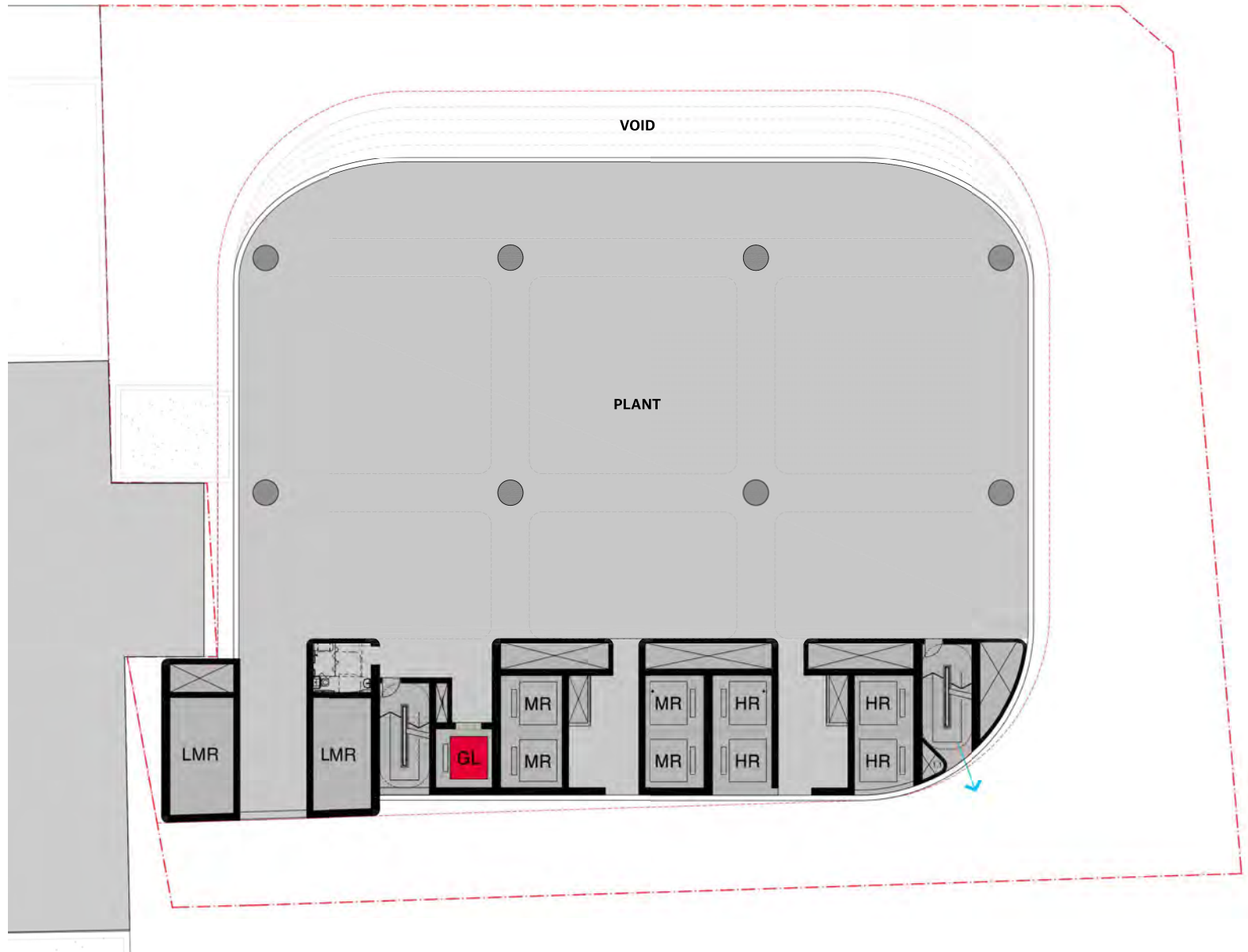

1:200 @ A3

MID RISE

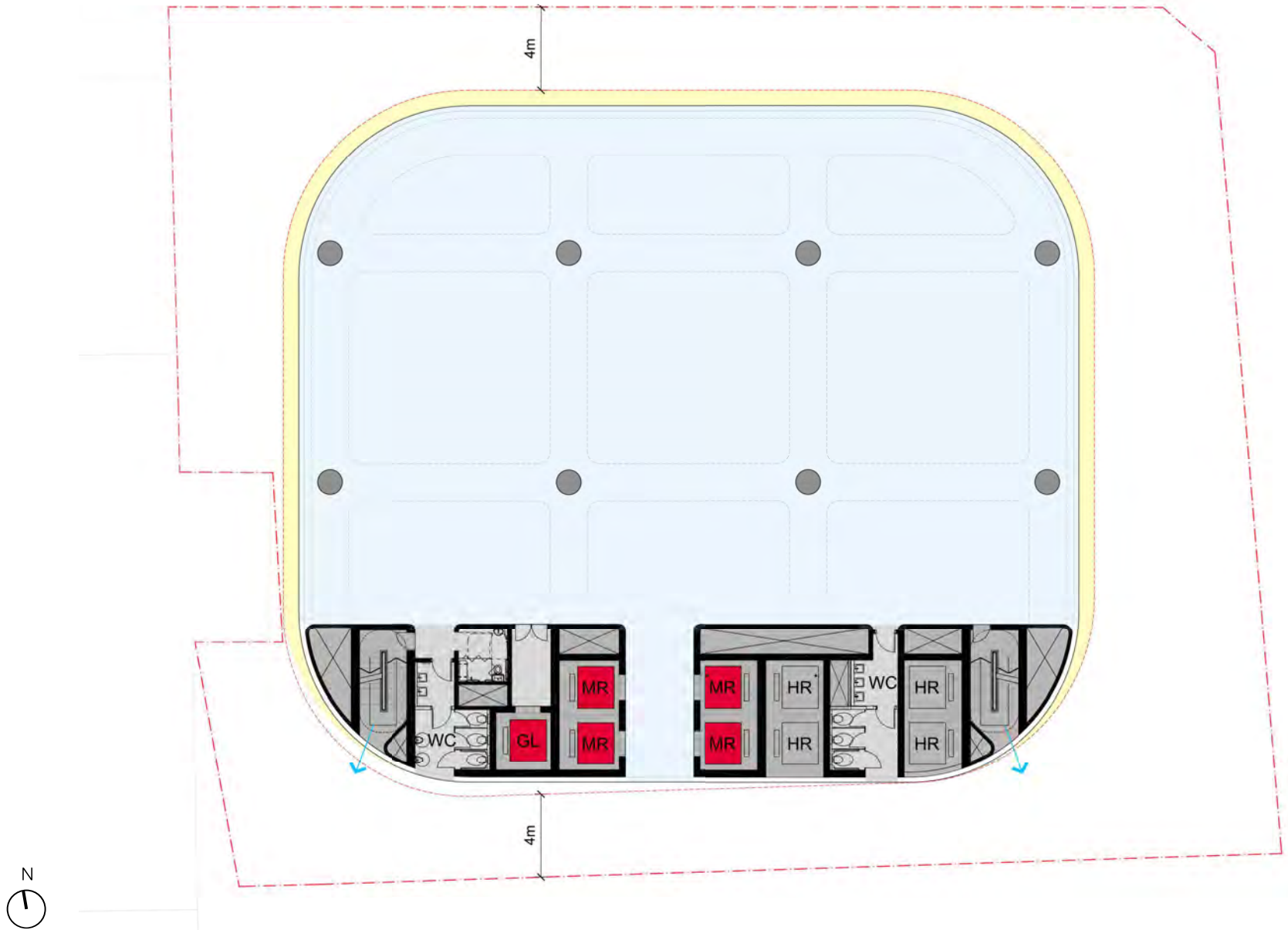

1:200 @ A3

LEVEL 34 LIFT TRANSFER

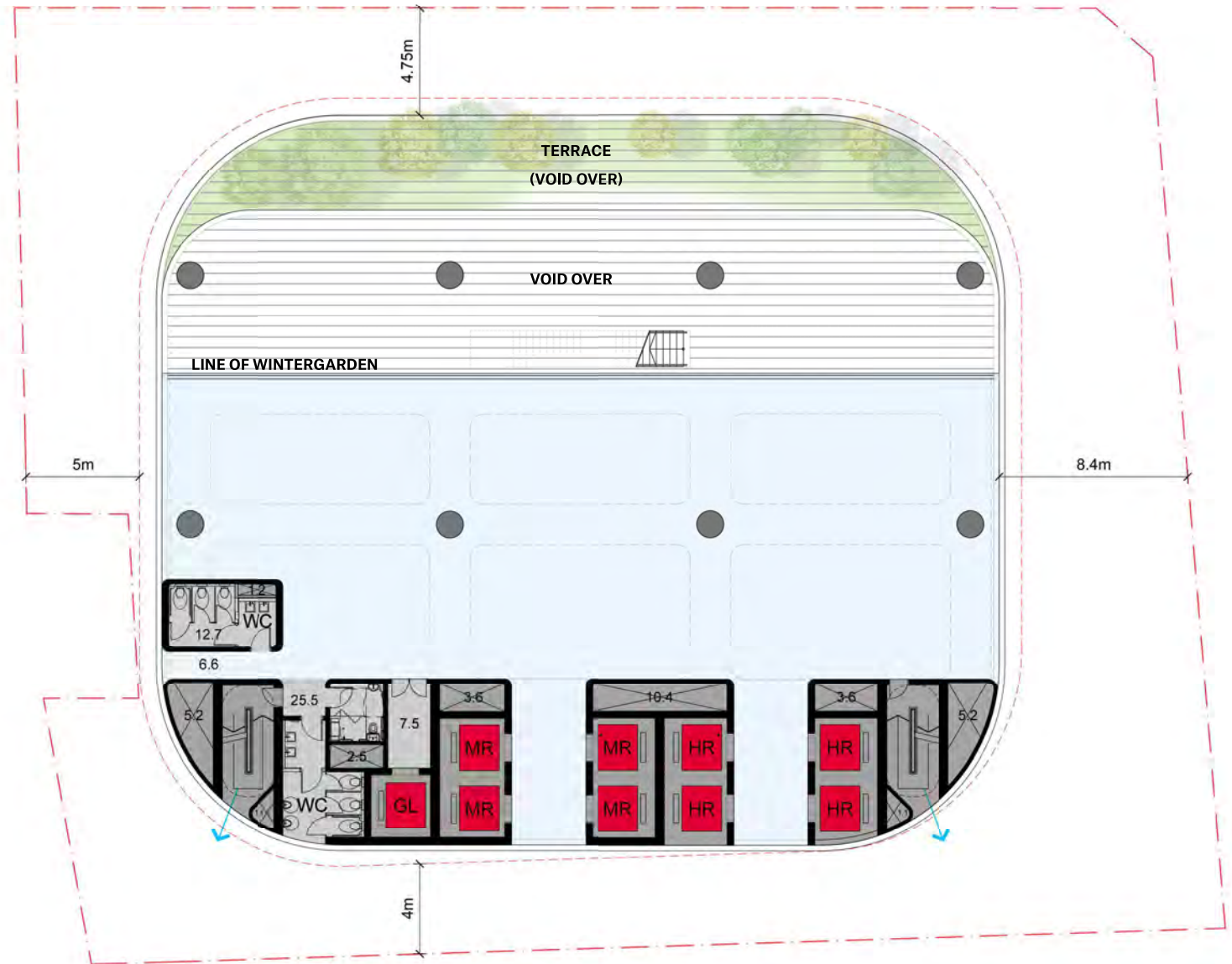

1:200 @ A3



LEVEL 35 OVER RUN FLOOR

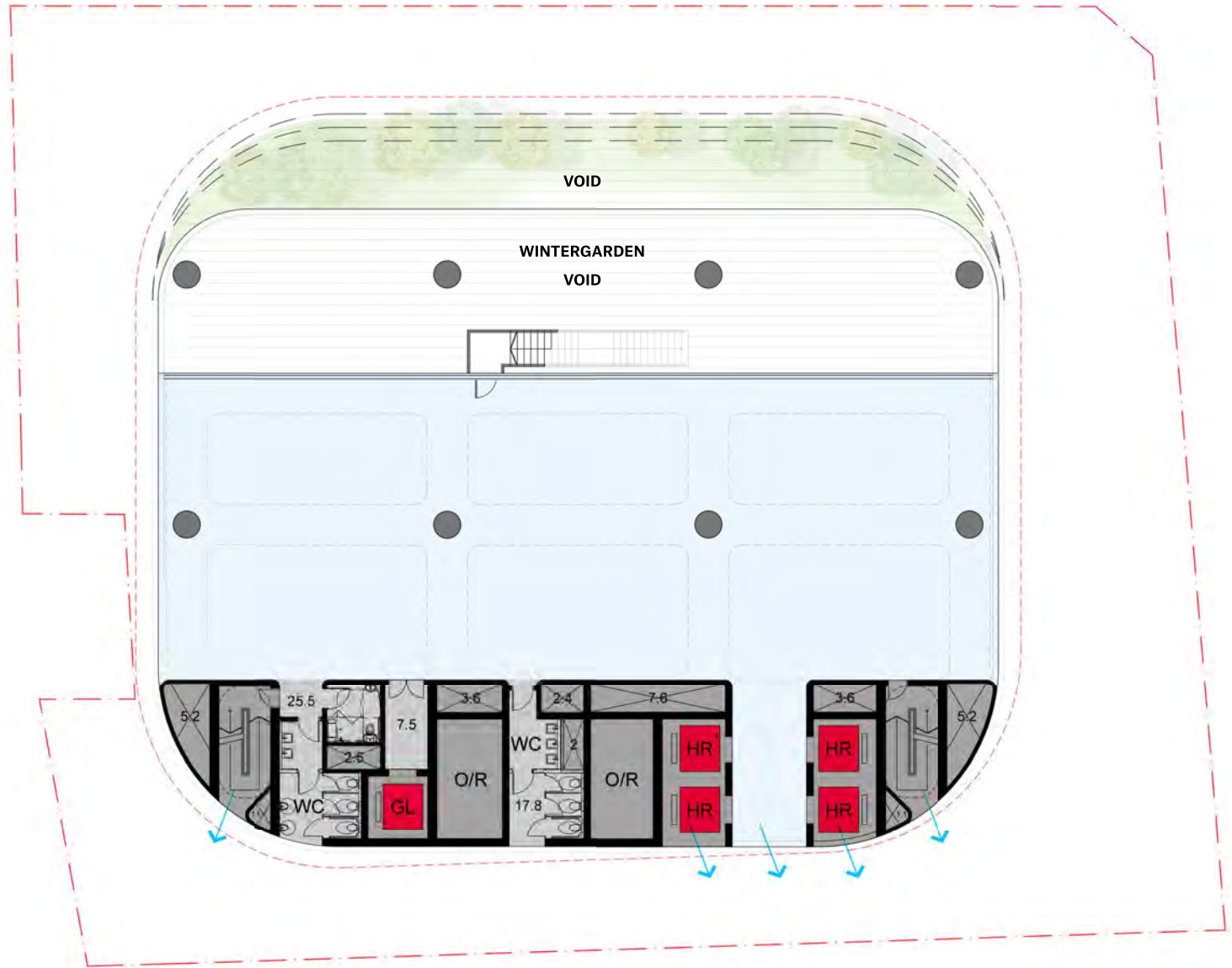

1:200 @ A3



HIGH RISE

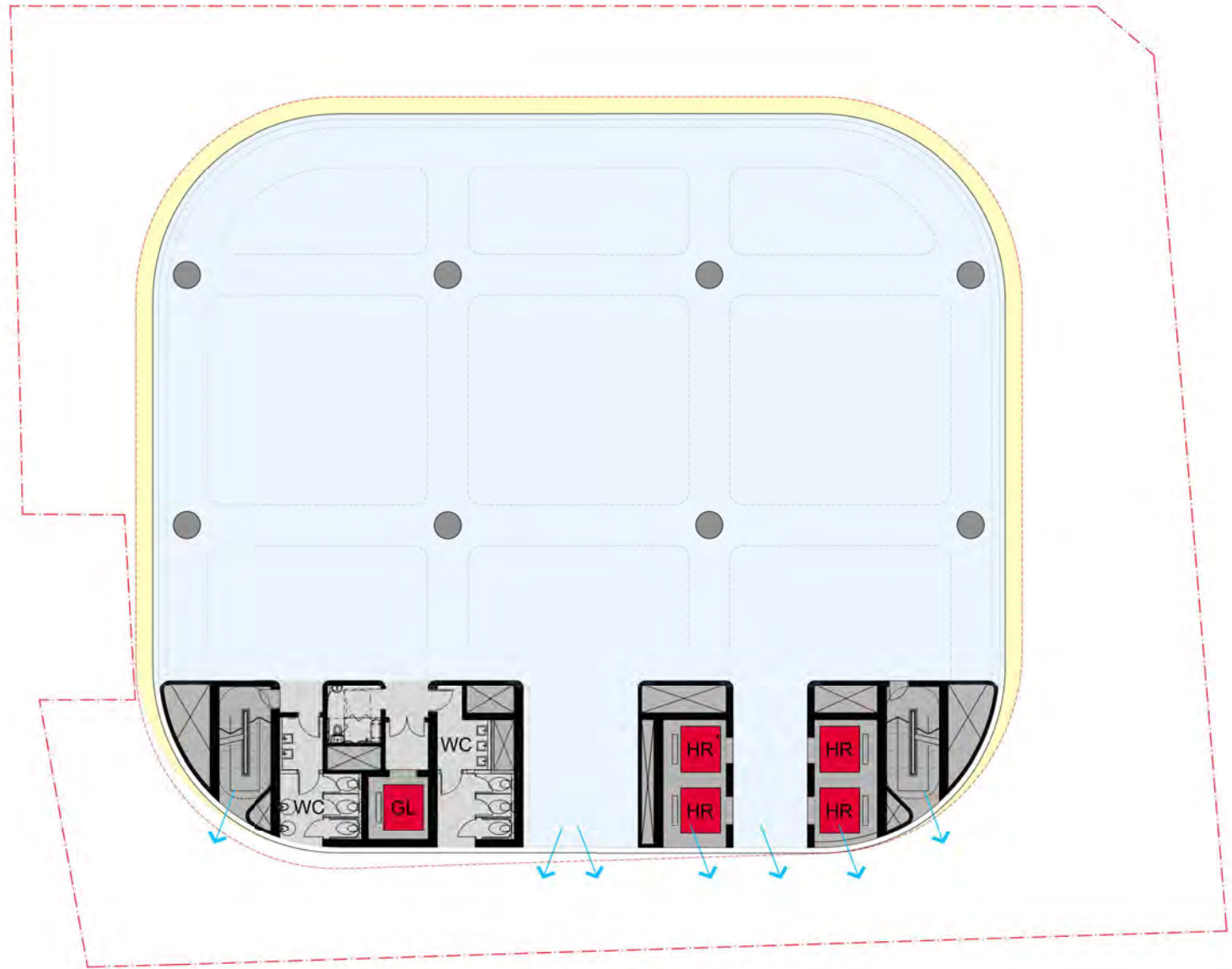

1:200 @ A3

LEVEL 49
Food & Beverage Lounge

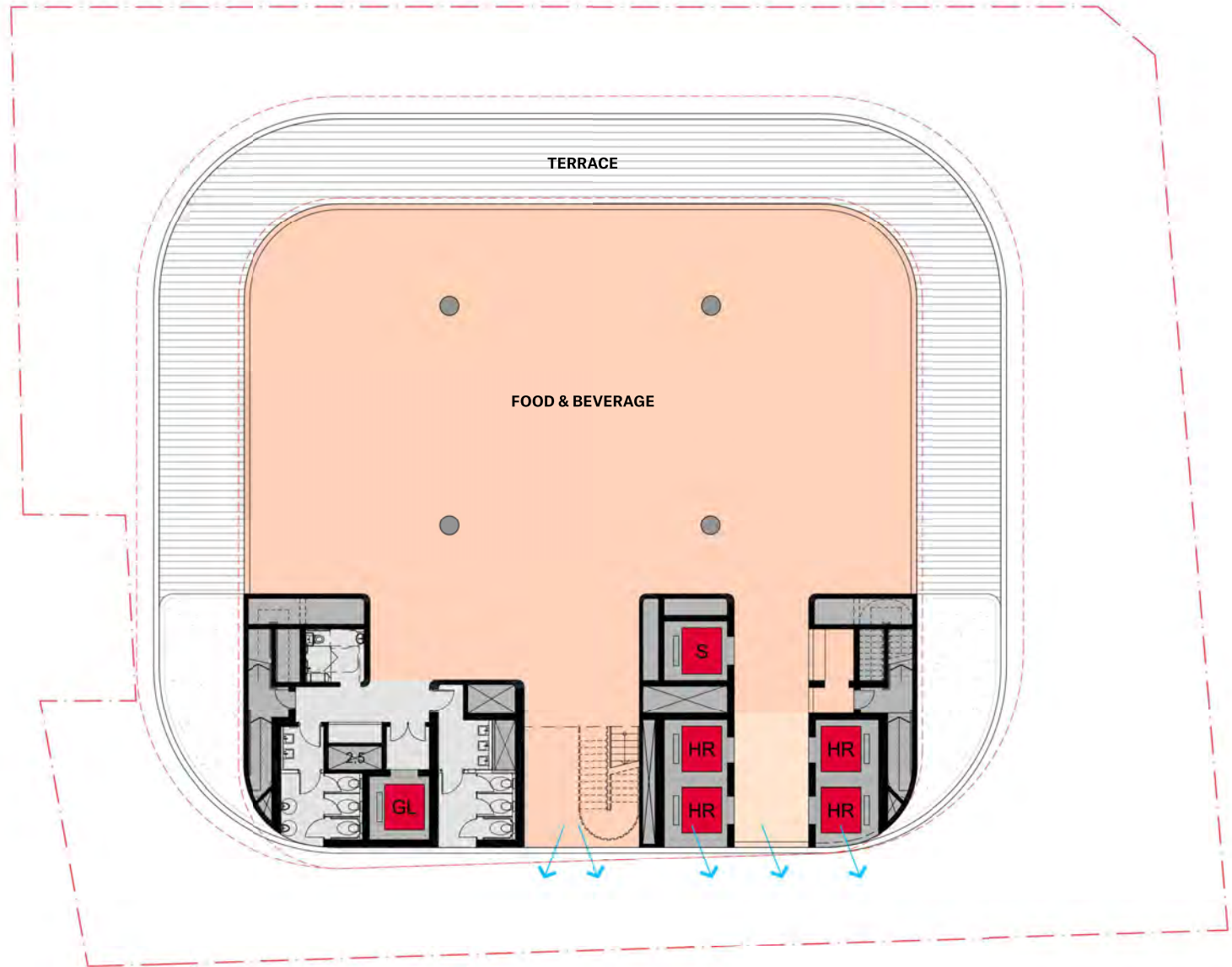

1:200 @ A3

LEVEL 50
Food & Beverage Lounge

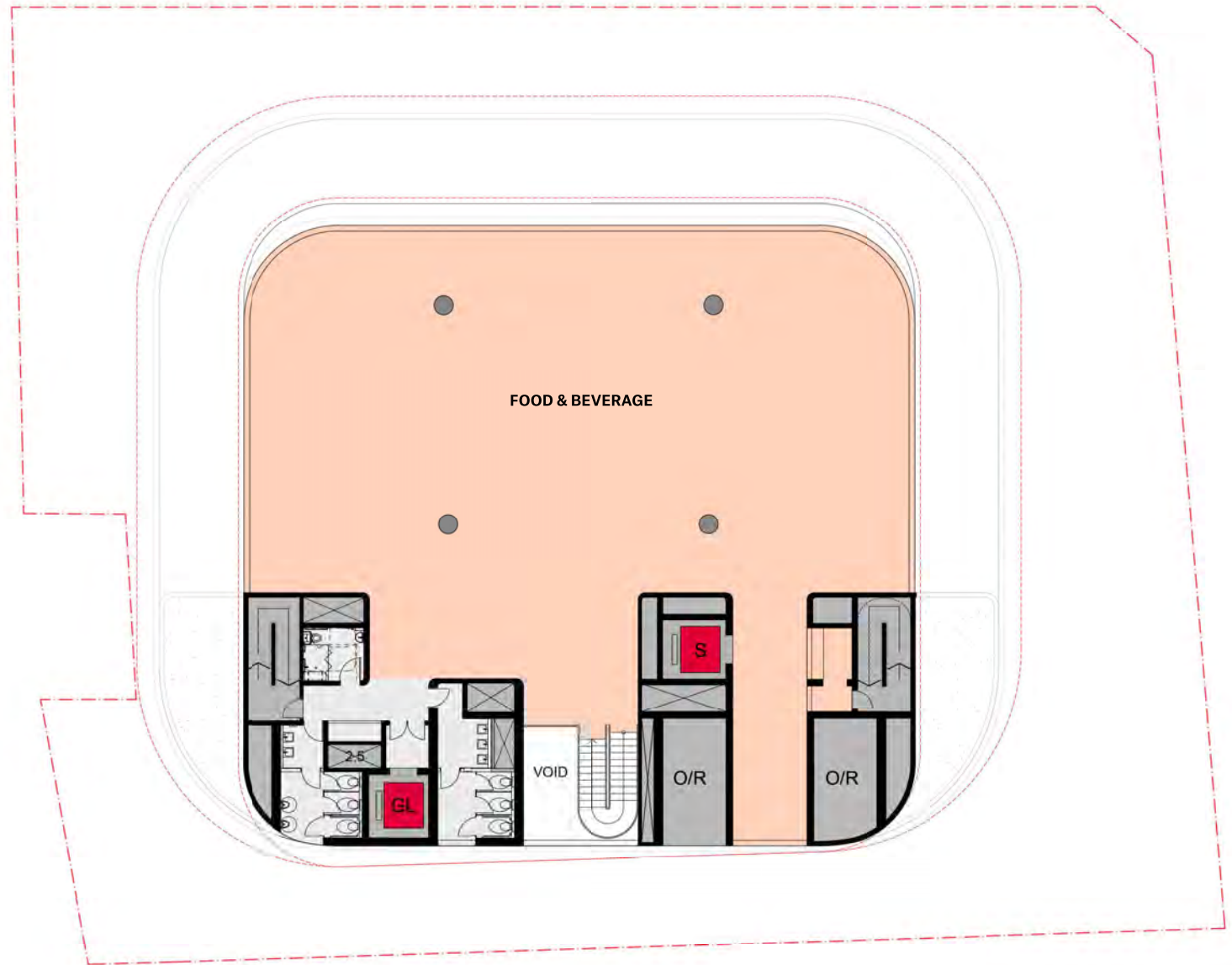

1:200 @ A3

LEVEL 51 PLANT

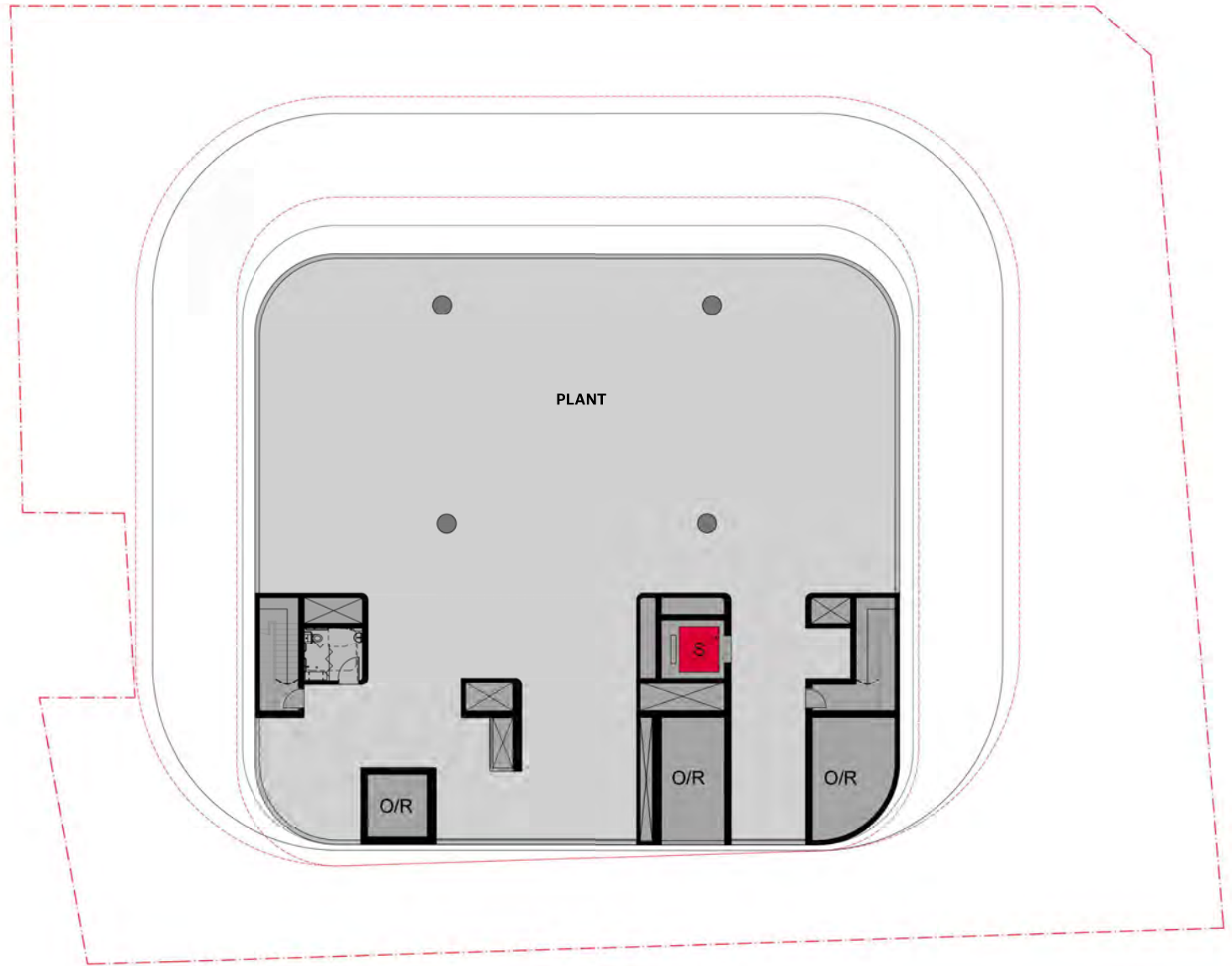

1:200 @ A3



INDICATIVE SECTION

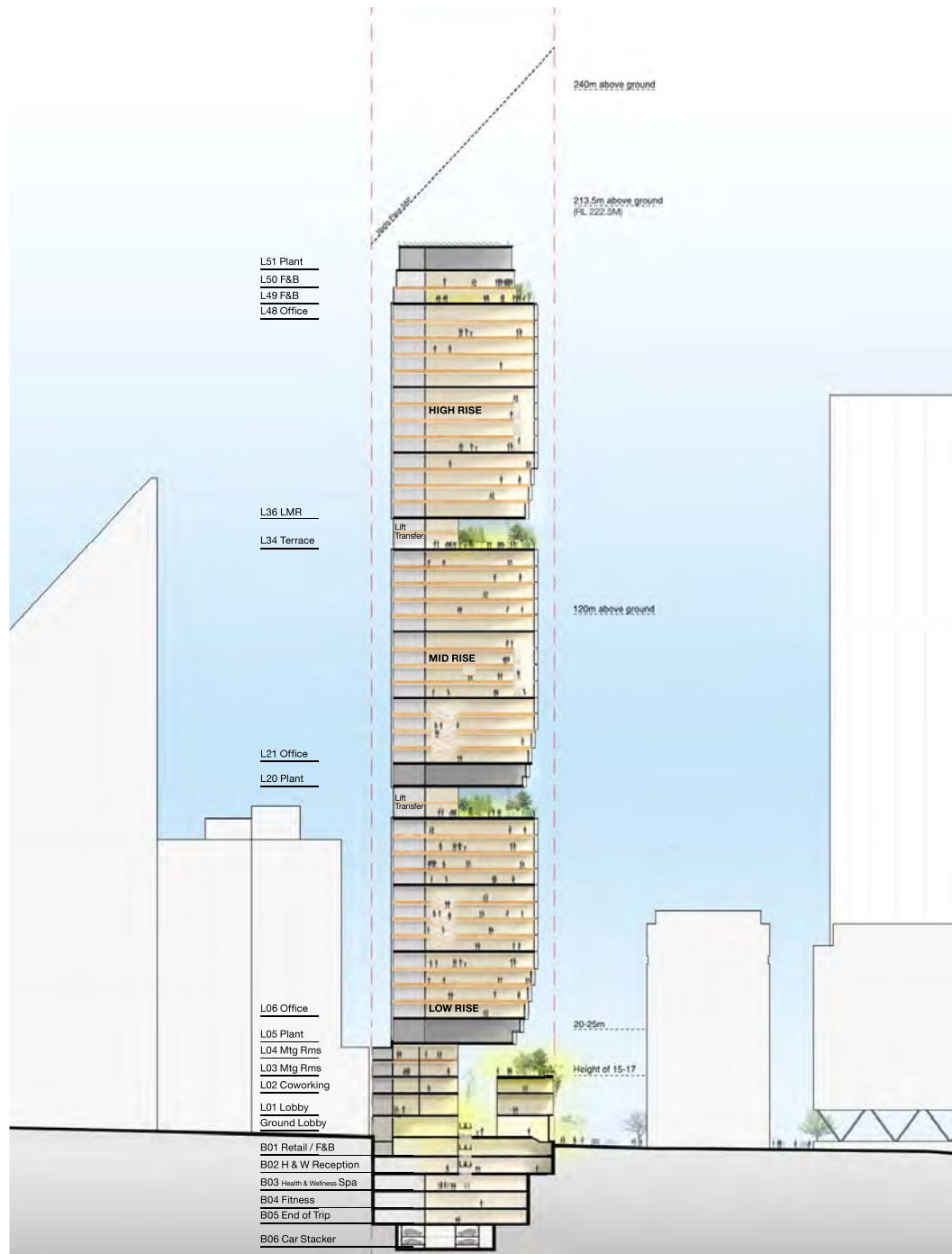

1:1000 @ A3

AREAS SCHEDULE

R. L.	DESCRIPTION	LEVEL	HEIGHT m	Envelope			Combined AA + FZ		GBA		CORE		GFA	GFA
				Area m ²	Volume m ³	layered volume	Area m ²	Volume m ³	layered volume	Area m ²	Volume m ³	Allowance (Excl. GFA)m ²	GFA	Area m ²
222.50	TOP OF ENVELOPE													
214.90	Above Plant (Above RL 216.0)		7.60	567,873	4,646	6.50, 1.10	567	4,646	0	0				
208.90	PLANT	10.50m	51	6.00	873	5,239	132	793	741	4,444				
205.15	Lounge Upper Level / Mezzanine	9.30m	50	3.75	1,196,873	3,613	388,65	475	808	3,030	143	78	666	
201.40	Lounge Roof Terrace (2m Balustrade)	8.70m	49	3.75	1,264,1,196	4,677	424,356	1,544	840	3,152	143	78	698	
197.65			48	3.75	1,264	4,742	82	309	1,183	4,433	143	80	1,040	
193.90			47	3.75	1,264	4,742	82	309	1,183	4,433	143	80	1,040	
190.15			46	3.75	1,264	4,742	82	309	1,183	4,433	143	80	1,040	
186.40			45	3.75	1,264	4,742	82	309	1,183	4,433	143	80	1,040	
182.65			44	3.75	1,264	4,742	82	309	1,183	4,433	143	80	1,040	
178.90			43	3.75	1,264	4,742	82	309	1,183	4,433	143	80	1,040	
175.15			42	3.75	1,264	4,742	82	309	1,183	4,433	143	80	1,040	
171.40	4.75 = 4m + 750mm Façade Zone		41	3.75	1,264	4,742	82	309	1,183	4,433	143	80	1,040	
167.65	Glazing Setback to Hunter St:		40	3.75	1,264	4,742	82	309	1,183	4,433	143	80	1,040	
163.90	4.75m typical		39	3.75	1,264	4,742	82	309	1,183	4,433	143	80	1,040	
160.15	5.35m Δ 0.60m		38	3.75	1,264	4,742	102	380	1,162	4,361	143	80	1,020	
156.40	HIGH RISE OFFICE	5.95m Δ 0.60m	37	3.75	1,264	4,742	123	459	1,142	4,283	143	80	999	
152.65	Motor Room Level	6.55m Δ 0.60m	36	3.75	1,264	4,742	143	537	1,121	4,205	183	78	938	
148.90	Lift Over Run / Void	9.00m Δ 2.45m	35	3.75	1,264	4,742	507	1,698	757	3,043	174	75	563	
145.15	Terrace / Lift Tranfer Level	9.00m Δ 0.00m	34	3.75	1,264	4,742	507	1,901	757	2,840	172	102	570	
141.40			33	3.75	1,264	4,742	82	309	1,183	4,433	183	78	999	
137.65			32	3.75	1,264	4,742	82	309	1,183	4,433	183	78	999	
133.90			31	3.75	1,264	4,742	82	309	1,183	4,433	183	78	999	
130.15			30	3.75	1,264	4,742	82	309	1,183	4,433	183	78	999	
126.40			29	3.75	1,264	4,742	82	309	1,183	4,433	183	78	999	
122.65			28	3.75	1,264	4,742	82	309	1,183	4,433	183	78	999	
118.90			27	3.75	1,264	4,742	82	309	1,183	4,433	183	78	999	
115.15			26	3.75	1,264	4,742	82	309	1,183	4,433	183	78	999	
111.40	4.75 = 4m + 750mm Façade Zone		25	3.75	1,264	4,742	82	309	1,183	4,433	183	78	999	
107.65	Glazing Setback to Hunter St:		24	3.75	1,264	4,742	82	309	1,183	4,433	183	78	999	
103.90	4.75m typical		23	3.75	1,264	4,742	82	309	1,183	4,433	183	78	999	
100.15	MID RISE OFFICE	5.35m Δ 0.60m	22	3.75	1,264	4,742	102	380	1,162	4,361	183	78	979	
96.40	Fire stair transfer level	5.95m Δ 0.60m	21	3.75	1,264	4,742	123	459	1,142	4,283	193	90	949	
90.40	Plant / Lift MR	6.55m Δ 0.60m / 7.15m Δ 0.60m	20	6.00	1,287	7,725	153	904	1,134	6,821				
86.65	Meeting Rooms	9.00m Δ 1.85m	19	3.75	1,311	4,998	504	1,688	807	3,310	263	117	591	
82.90	Terrace / Lift Tranfer Level	9.00m Δ 0.00m	18	3.75	1,341	5,027	504	1,890	837	3,137	268	117	591	
79.15			17	3.75	1,341	5,027	82	309	1,259	4,718	223	79	1,032	
75.40			16	3.75	1,341	5,027	82	309	1,259	4,718	223	79	1,032	
71.65			15	3.75	1,341	5,027	82	309	1,259	4,718	223	79	1,032	
67.90			14	3.75	1,341	5,027	82	309	1,259	4,718	223	79	1,032	
64.15	LOW RISE OFFICE		13	3.75	1,341	5,027	82	309	1,259	4,718	223	79	1,032	
60.40			12	3.75	1,341	5,027	82	309	1,259	4,718	223	79	1,032	
56.65	4.75 = 4m + 750mm Façade Zone		11	3.75	1,341	5,027	82	309	1,259	4,718	223	79	1,032	
52.90	Glazing Setback to Hunter St:		10	3.75	1,341	5,027	82	309	1,259	4,718	223	79	1,032	
49.15	4.75m typical		9	3.75	1,341	5,027	82	309	1,259	4,718	223	79	1,032	
45.40	5.25m Δ 0.50m		8	3.75	1,341	5,027	103	383	1,238	4,644	223	79	1,015	
41.65	6.00m Δ 0.75m		7	3.75	1,341	5,027	128	478	1,212	4,549	223	79	989	
37.90	6.90m Δ 0.90m		6	3.75	1,341	5,027	159	593	1,181	4,434	223	79	958	
31.90	Podium Plant	8.00m Δ 1.10m / 9.50m Δ 1.50m	5	6.00	1,341	7,737	188	1,532	1,153	6,204				
28.15	Podium Level 04	Meeting Rooms	4	3.75	1,622	6,526	766	2,746	856	3,780			621	
24.40	Terrace / L03	Hunter St Podium Roof Terrace	3	3.75	2,101	6,653	1,186	2,939	915	3,714			677	
20.40	Podium Level 02	Co-working	2	4.00	2,101	8,262	513	2,054	1,587	6,209			1,378	
15.40	Podium Level 01	Commercial Lobby	1	5.00	2,101	10,609	554	2,772	1,546	7,837			1,352	
10.40 *	Ground Level	Laneway Retail	GL	5.00	2,101	10,503	584	2,921	1,517	7,583			1,048	
6.10	Basement B01	Food Market & Bligh Metro / Loading	B01		1,647				1,775				555	
2.00	Basement B02	Health + Wellness Reception	B02		1,647				1,775				687	
-2.00	Basement B03	Health + Wellness Treatments & Studios	B03		1,647				1,549				1,335	
-6.00	Basement B04	Health + Wellness Gym	B04		1,647				1,549				1,335	
-9.50	Basement B05	End of Trip	B05		1,647				1,549				1,335	
-15.00	Basement B06	Commercial Car Stacker	B06		808				952					

* Highest existing footpath RL outside vehicular entry zone is RL 10.40, and lowest existing footpath RL is RL 8.70.

Site Area:	2,108.1 m ²	Envelope		Façade Zone + Articulation		GBA		CORE A.		FSR	GFA
		Area	Volume	Area	Volume	Area	Volume	Area	Volume		
Above Ground:		70,693 m ²	279,300 m ³	10,912 m ²	43,442 m ³	59,781 m ²	235,769 m ³	8,127	22.43 : 1		47,284 m ²
Below Ground:								9,149 m ²	Excluding EoT Including EoT:	1.86 : 1 2.49 : 1	3,912 m ² 5,247 m ²
Total:								68,930 m ²	Above & Below:	24.92 : 1	52,531 m ²

APPENDIX B

SWEPT PATH DIAGRAMS



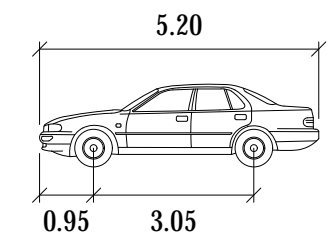
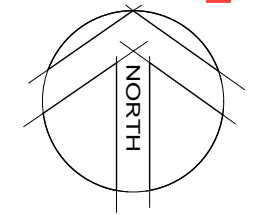
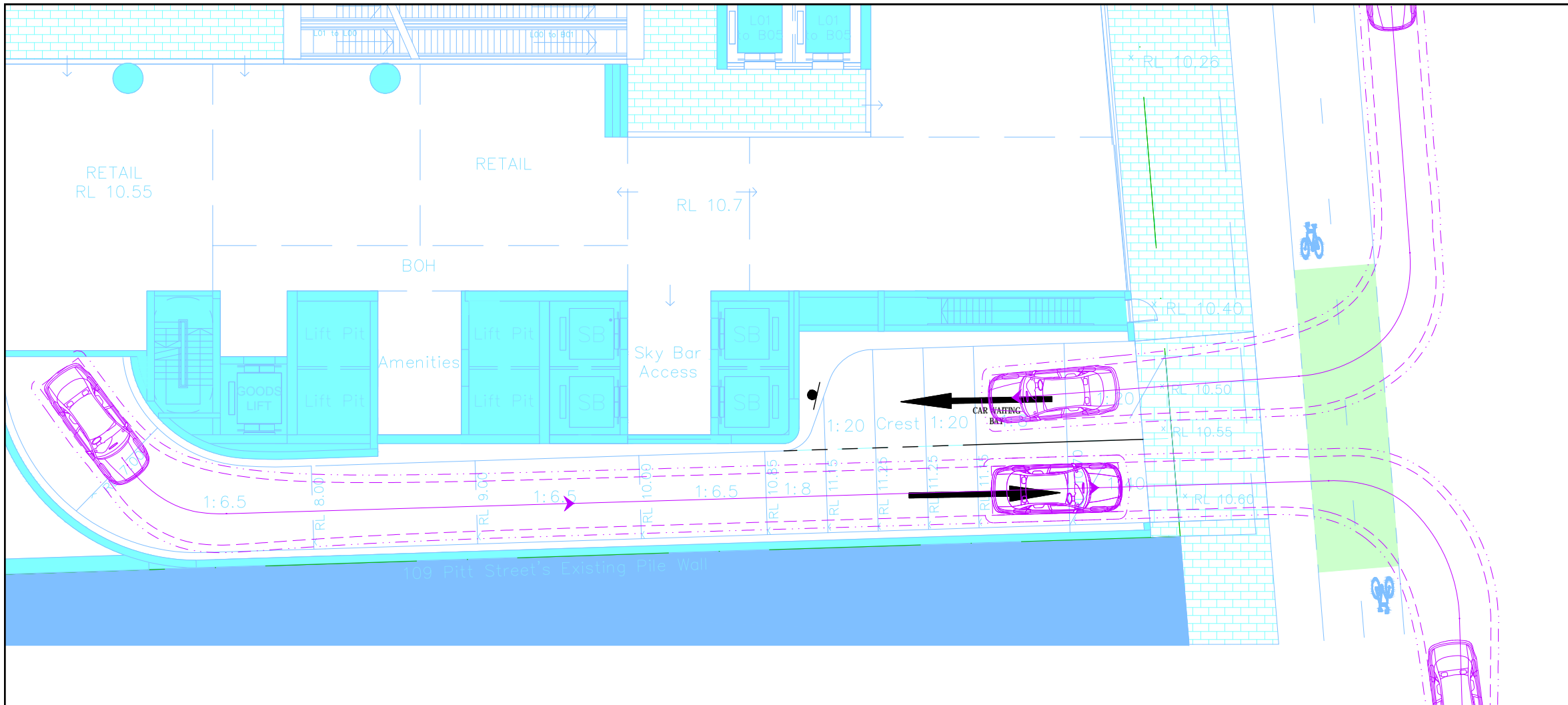

B99	meters
Width	: 1.94
Track	: 1.84
Lock to Lock Time	: 6.00
Steering Angle	: 33.50

VEHICLE LEGEND

- B99CAR 300mm CLEARANCE
- B99CAR OVERHANG
- B99CAR CENTRELINE

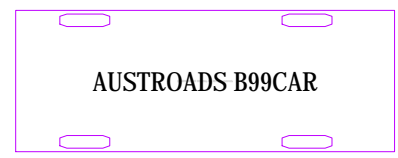

PS120302 SK041
GROUND LEVEL
B99 CAR - SITE INGRESS/EGRESS
C.H. 10.02.2022



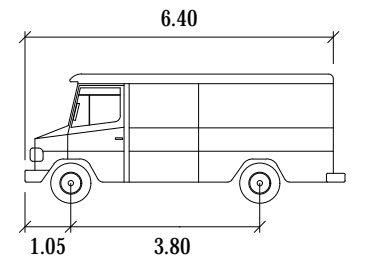
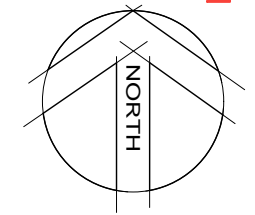
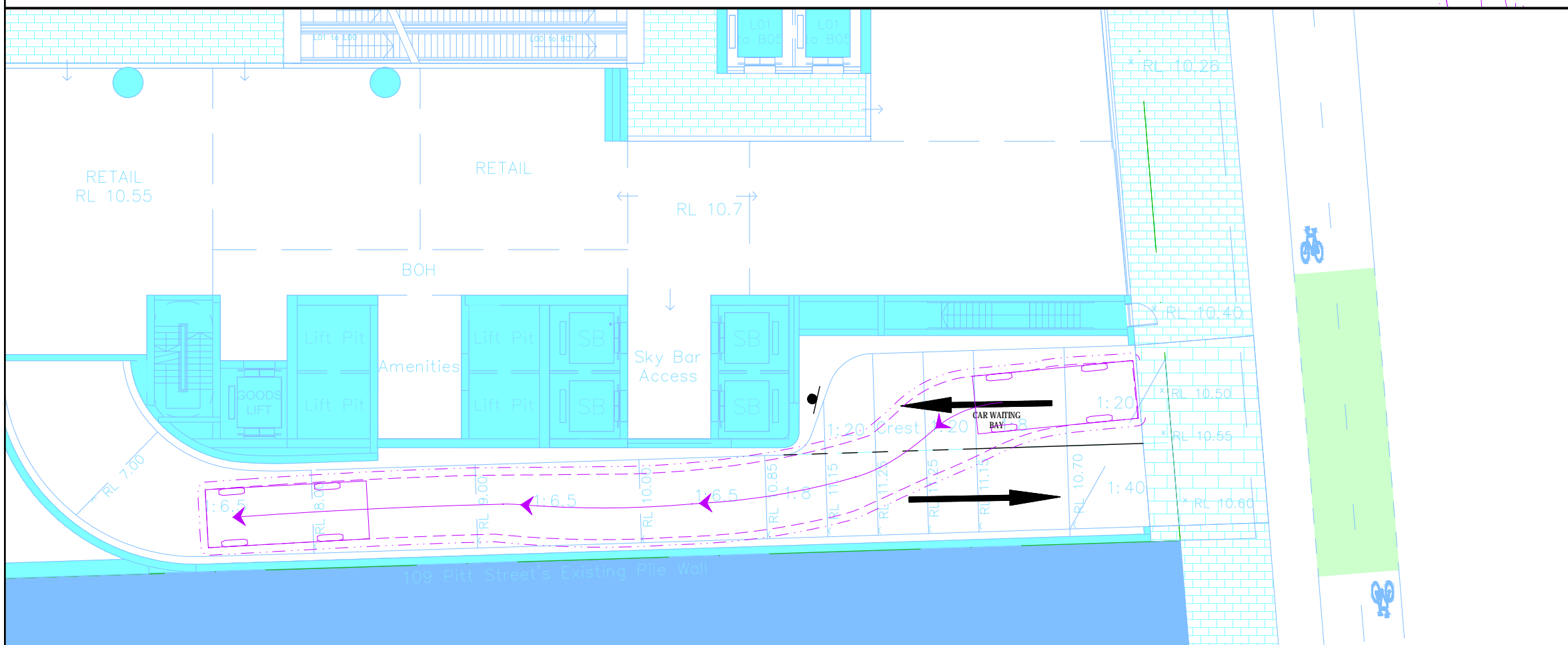

SRV	units
Width	: 2.30
Track	: 2.30
Lock to Lock Time	: 6.0
Steering Angle	: 38.0

VEHICLE LEGEND

- 6.4m SRV 300mm CLEARANCE
- 6.4m SRV OVERHANG
- 6.4m SRV CENTRELINE

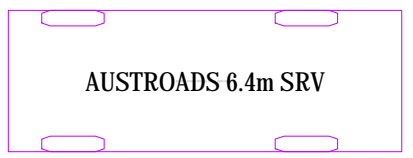

PS120302 SK042

GROUND LEVEL
6.4m SRV - SITE INGRESS/EGRESS
C.H. 10.02.2022



GENERAL NOTE: 300mm VEHICLE CLEARANCE USED DUE TO LOW SPEED ENVIRONMENT

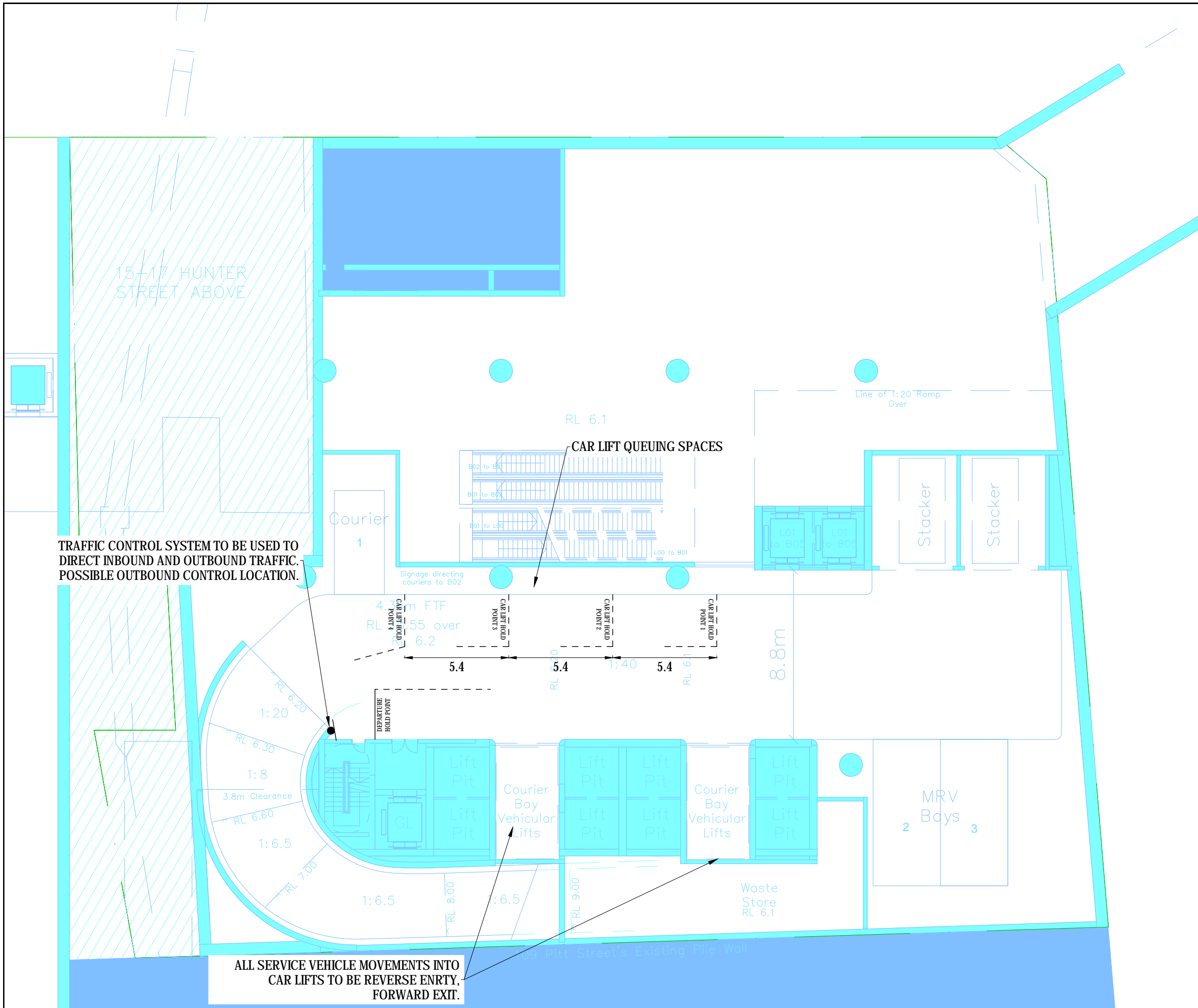
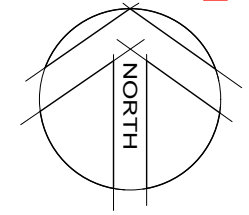

TRAFFIC CONTROL SYSTEM TO BE USED TO DIRECT INBOUND AND OUTBOUND TRAFFIC. POSSIBLE OUTBOUND CONTROL LOCATION.

ALL SERVICE VEHICLE MOVEMENTS INTO CAR LIFTS TO BE REVERSE ENTRY, FORWARD EXIT.

PS120302 SK043
BASEMENT LEVEL 1
GENERAL DESIGN COMMENTS

C.H. 10.02.2022



SCALE 1:200 @A3

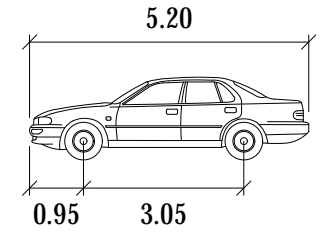
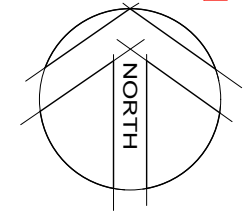

B99	metres
Width	: 1.94
Track	: 1.84
Lock to Lock Time	: 6.00
Steering Angle	: 33.50

VEHICLE LEGEND

- B99CAR 300mm CLEARANCE
- B99CAR OVERHANG
- B99CAR CENTRELINE

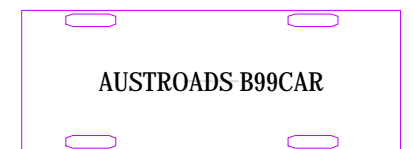

PS120302 SK044

**BASEMENT LEVEL 1
B99 - CAR STACKER INGRESS/EGRESS**

C.H. 10.02.2022

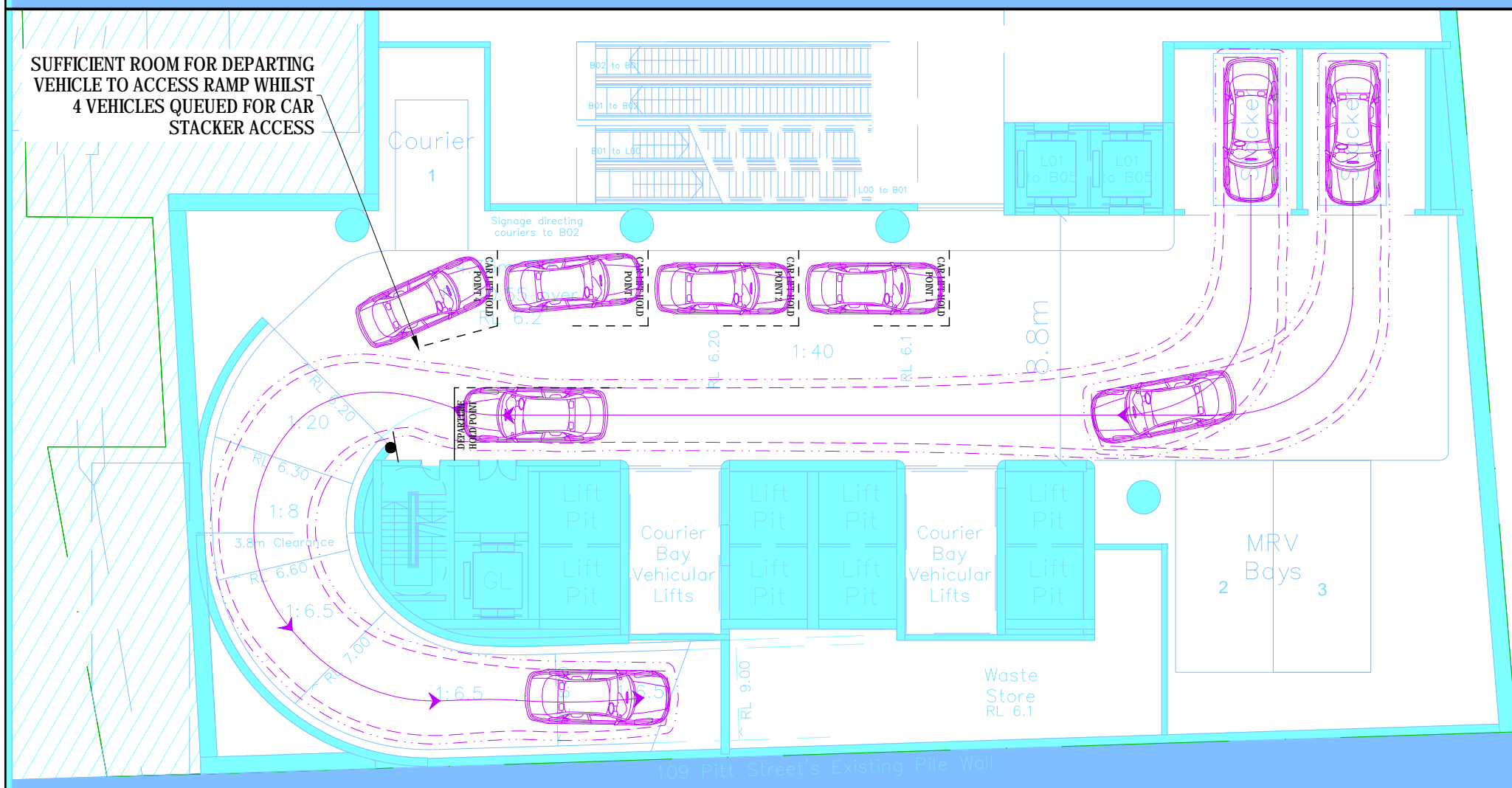
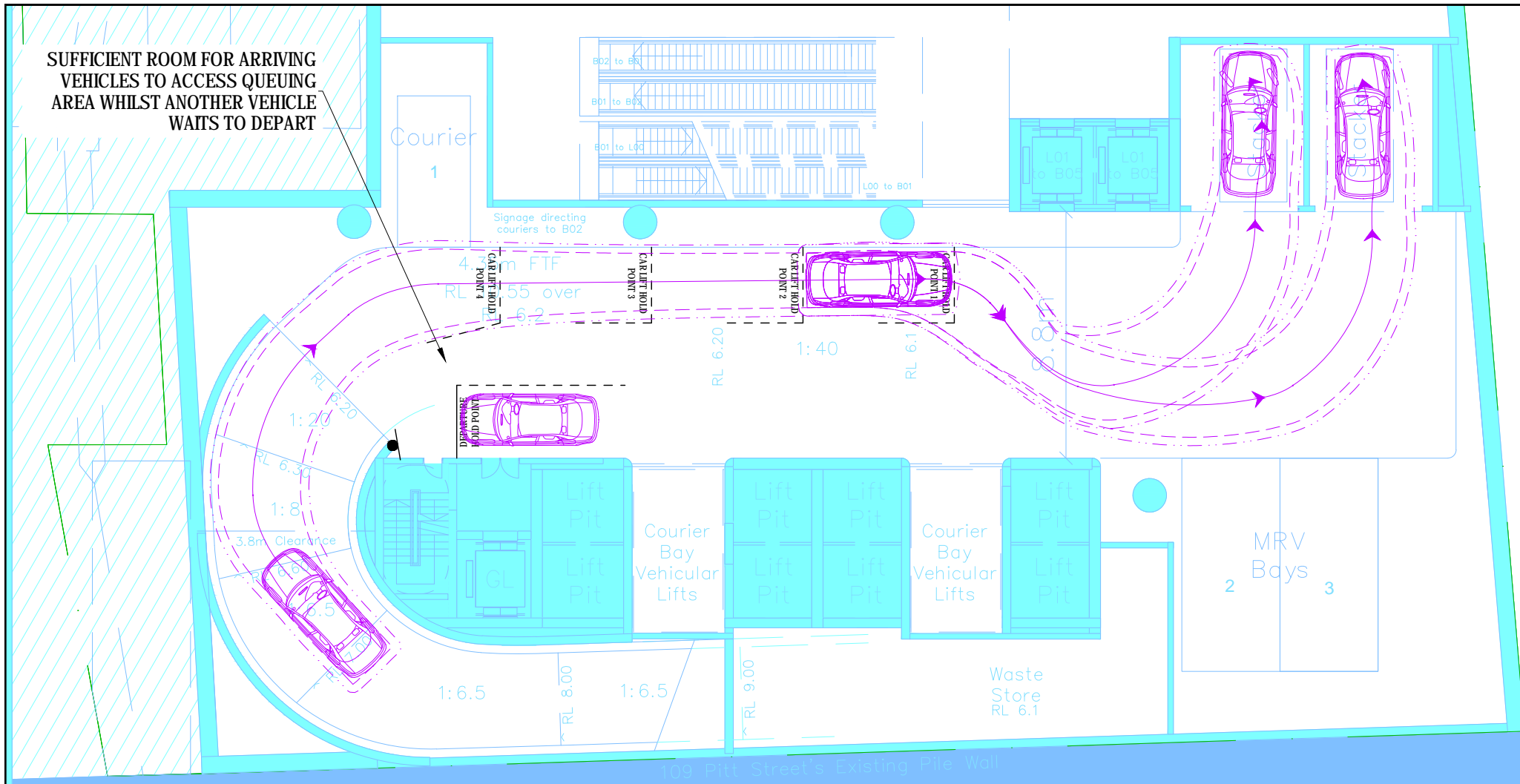

SERVICE VEHICLE MOVEMENTS TO LIFT TO BE UNDERTAKEN OUTSIDE OF PEAK TIMES WHEN NO VEHICLES ARE IN THE CAR STACKER QUEUING SPACES.

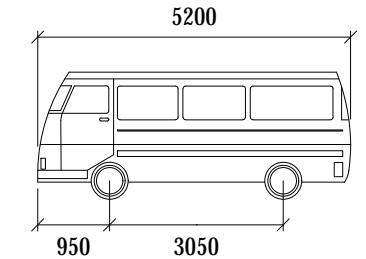
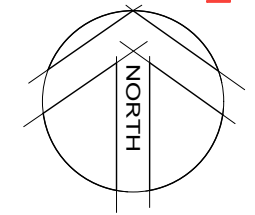
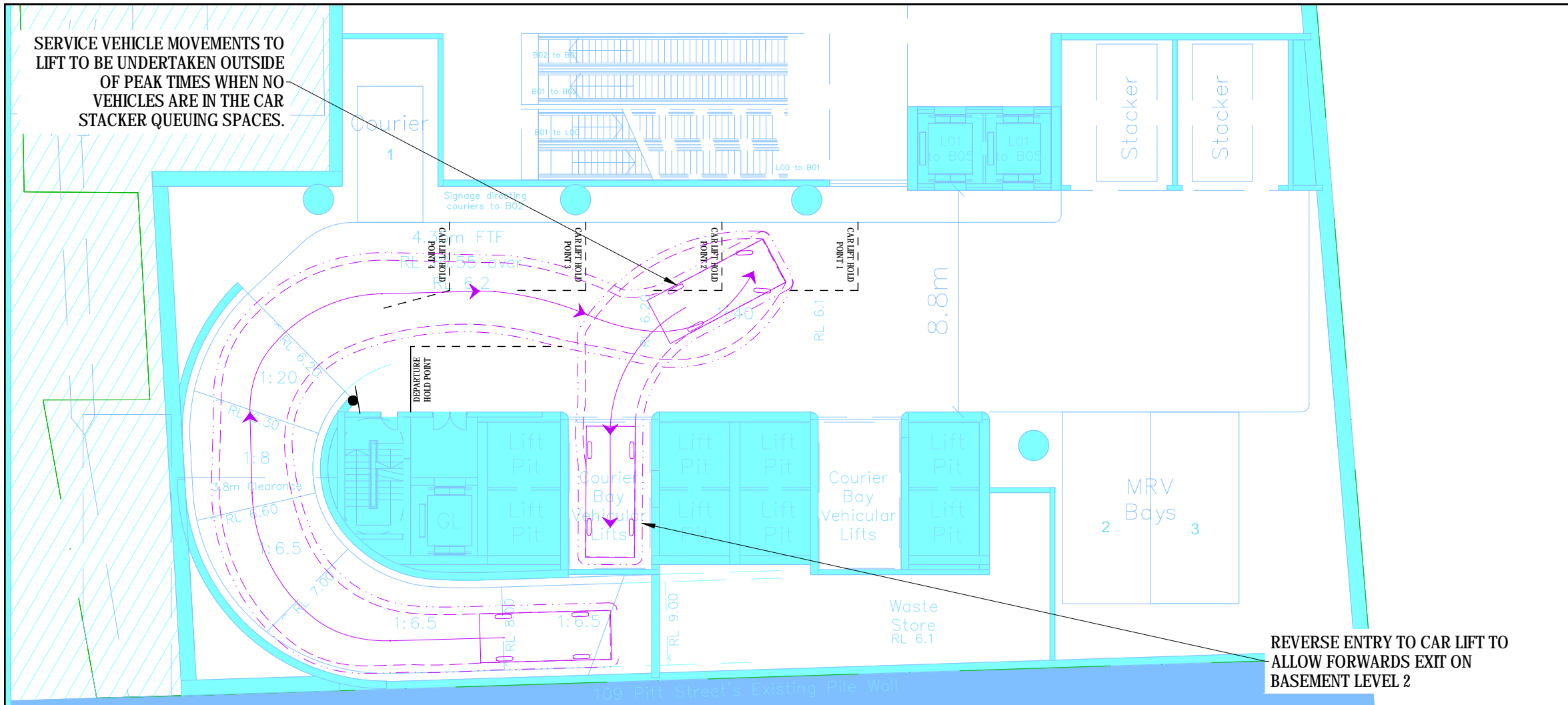

VAN	mm
Width	: 1940
Track	: 1840
Lock to Lock Time	: 6.0
Steering Angle	: 33.5

REVERSE ENTRY TO CAR LIFT TO ALLOW FORWARDS EXIT ON BASEMENT LEVEL 2

SERVICE VEHICLE MOVEMENTS TO LIFT TO BE UNDERTAKEN OUTSIDE OF PEAK TIMES WHEN NO VEHICLES ARE IN THE CAR STACKER QUEUING SPACES.

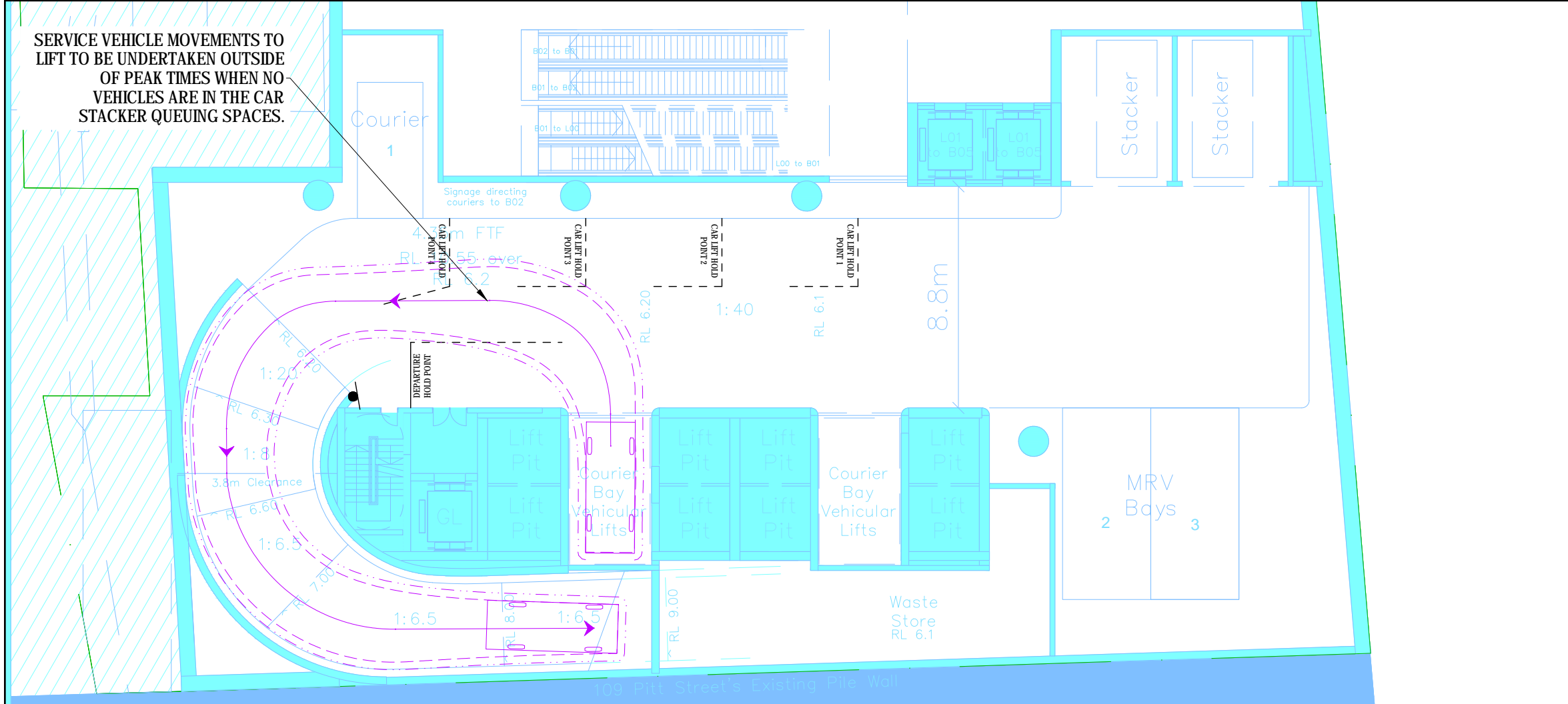

VEHICLE LEGEND

- 5.2m VAN 300mm CLEARANCE
- 5.2m VAN OVERHANG
- 5.2m VAN CENTRELINE

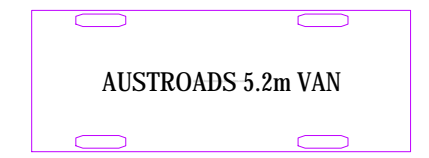

PS120302 SK045

BASEMENT LEVEL 1
B99 VAN - CAR LIFT INGRESS/EGRESS 01

C.H. 10.02.2022

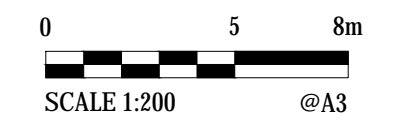

SERVICE VEHICLE MOVEMENTS TO LIFT TO BE UNDERTAKEN OUTSIDE OF PEAK TIMES WHEN NO VEHICLES ARE IN THE CAR STACKER QUEUING SPACES.

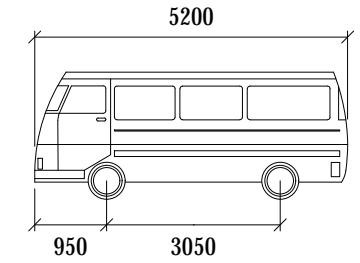
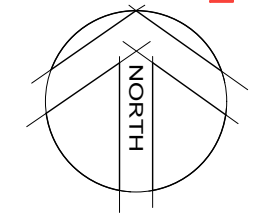
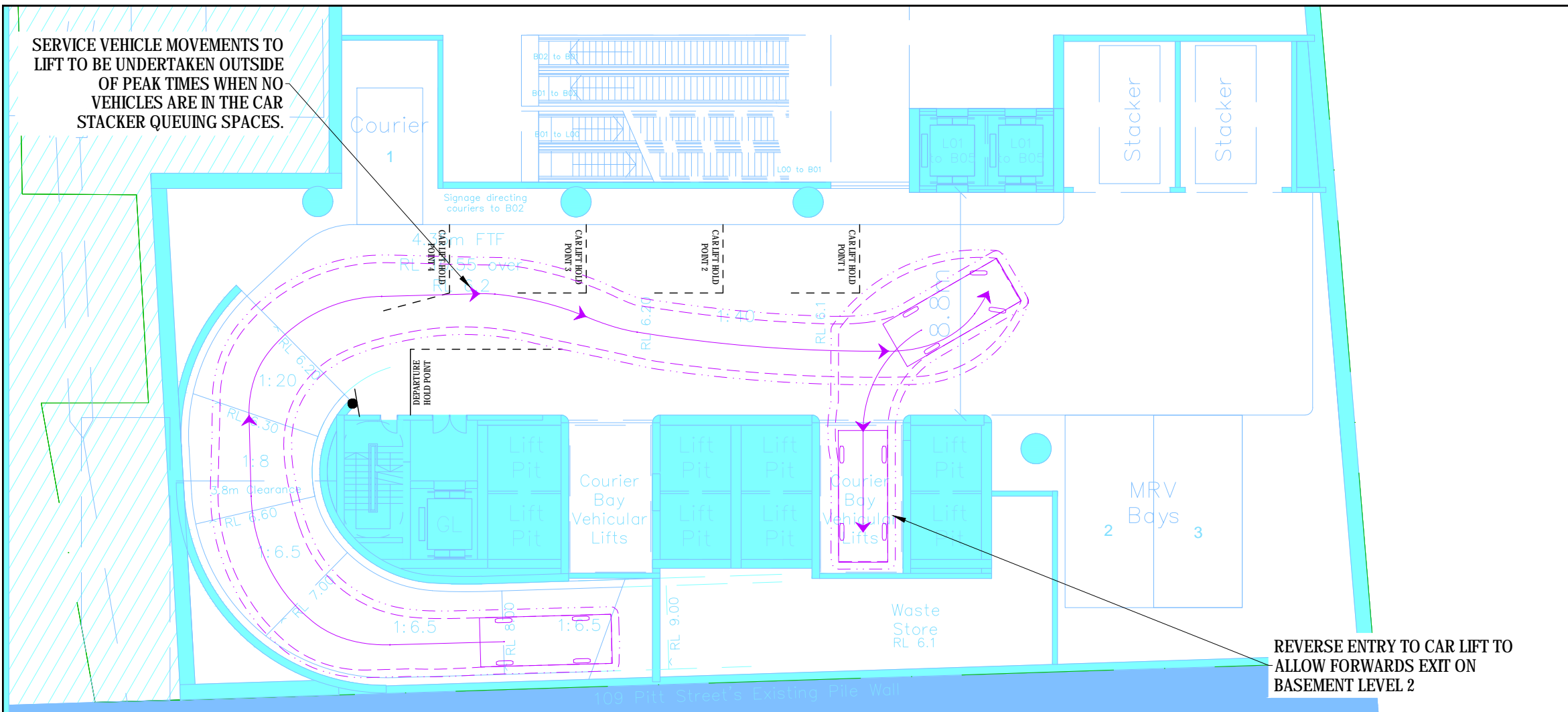

VAN	mm
Width	: 1940
Track	: 1840
Lock to Lock Time	: 6.0
Steering Angle	: 33.5

REVERSE ENTRY TO CAR LIFT TO ALLOW FORWARDS EXIT ON BASEMENT LEVEL 2

SERVICE VEHICLE MOVEMENTS TO LIFT TO BE UNDERTAKEN OUTSIDE OF PEAK TIMES WHEN NO VEHICLES ARE IN THE CAR STACKER QUEUING SPACES.

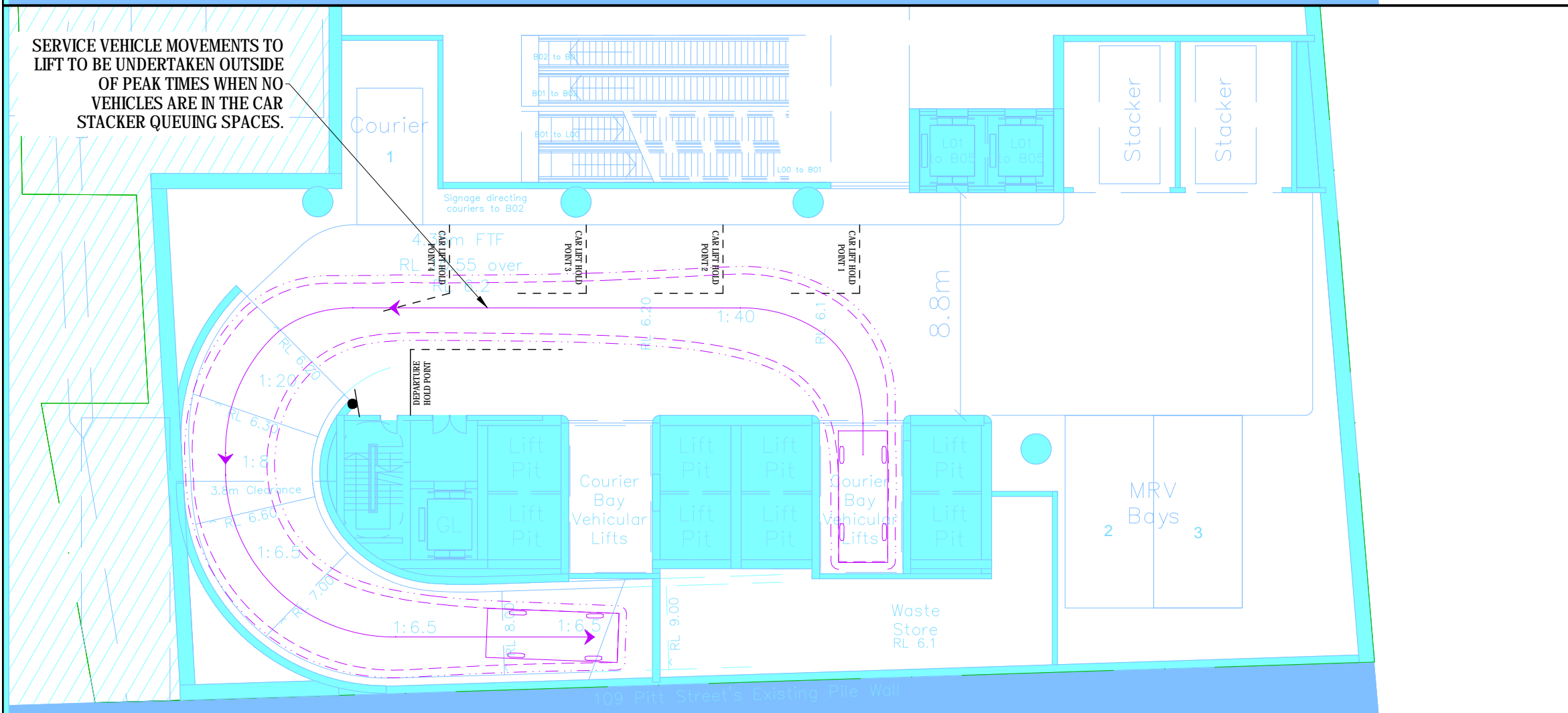

VEHICLE LEGEND

- 5.2m VAN 300mm CLEARANCE
- 5.2m VAN OVERHANG
- 5.2m VAN CENTRELINE



PS120302 SK046

BASEMENT LEVEL 1

B99 VAN - CAR LIFT INGRESS/EGRESS 02

C.H. 10.02.2022

0 5 8m



SCALE 1:200 @A3

SERVICE VEHICLE MOVEMENTS TO BE UNDERTAKEN OUTSIDE OF PEAK TIMES WHEN NO VEHICLES ARE IN THE CAR STACKER QUEUING SPACES.

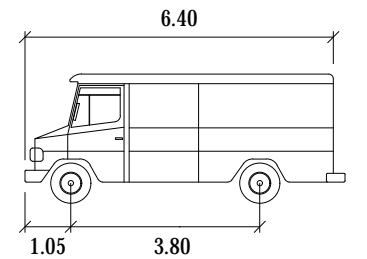
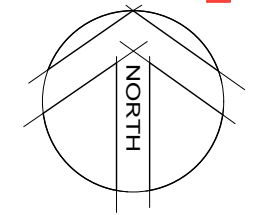
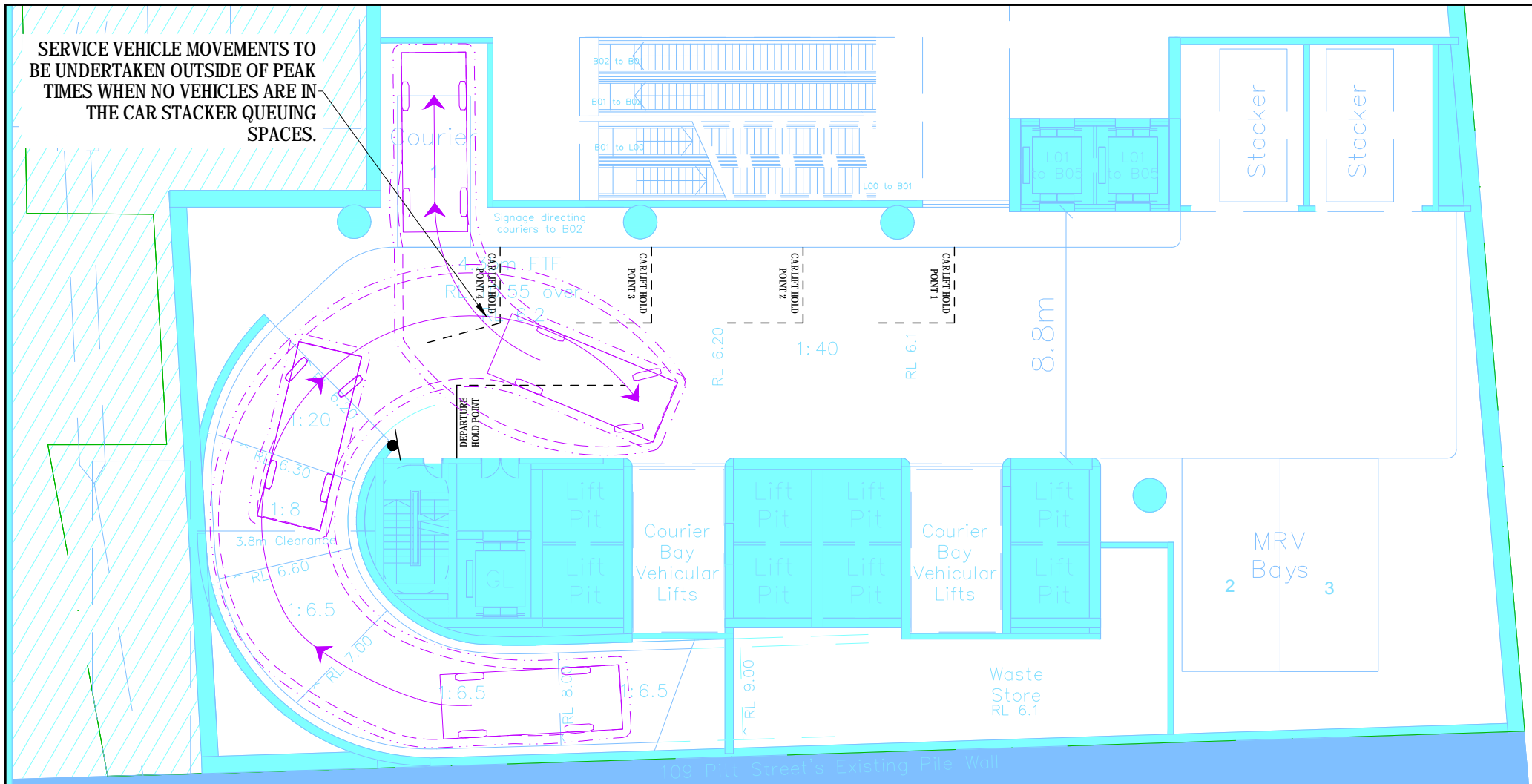

SRV	units
Width	: 2.30
Track	: 2.30
Lock to Lock Time	: 6.0
Steering Angle	: 38.0

SERVICE VEHICLE MOVEMENTS TO BE UNDERTAKEN OUTSIDE OF PEAK TIMES WHEN NO VEHICLES ARE IN THE CAR STACKER QUEUING SPACES.

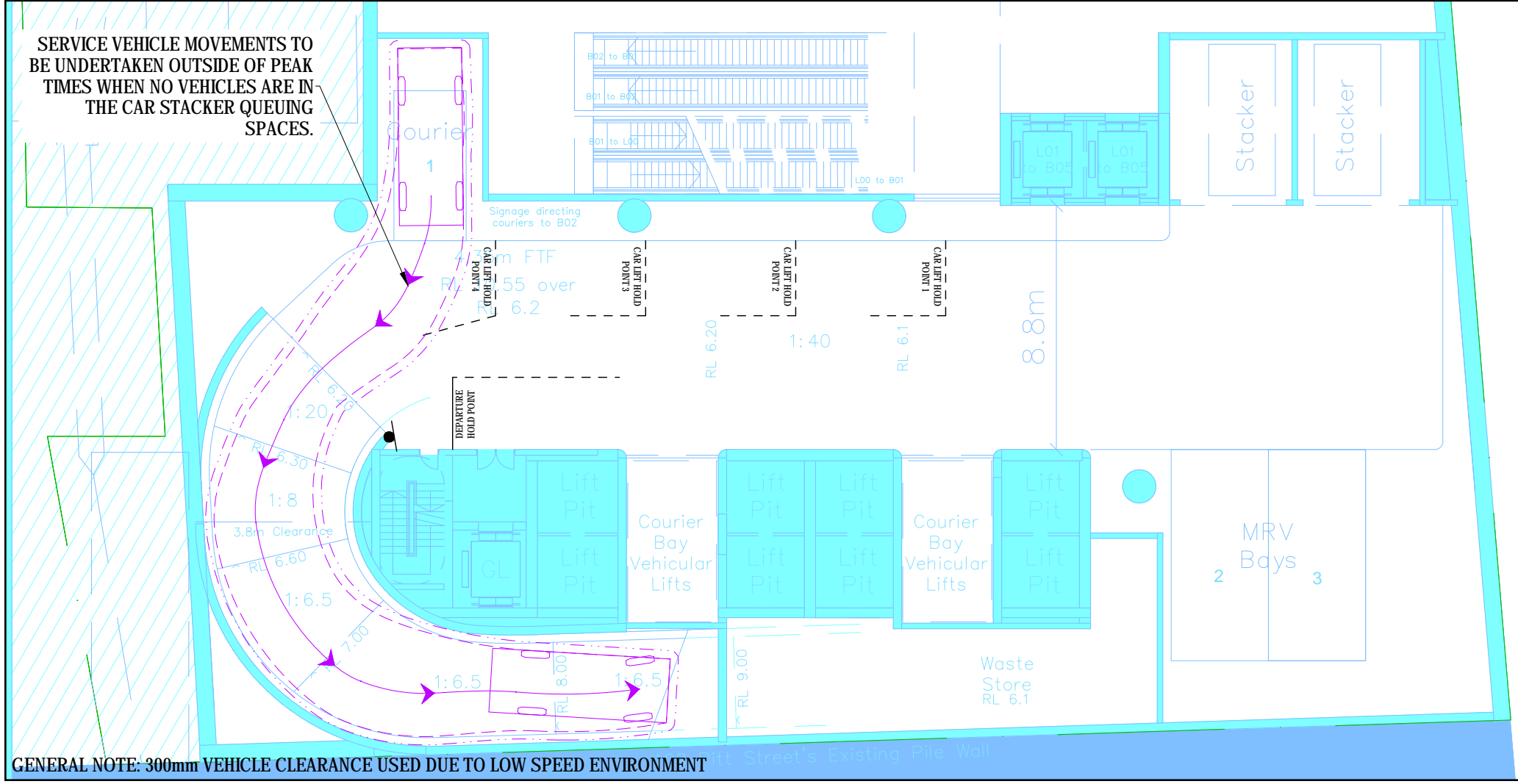

VEHICLE LEGEND

- 6.4m SRV 300mm CLEARANCE
- 6.4m SRV OVERHANG
- 6.4m SRV CENTRELINE

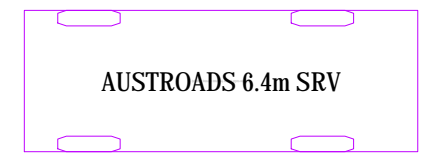

PS120302 SK047

BASEMENT LEVEL 1
6.4m SRV - SITE INGRESS/EGRESS 01
C.H. 10.02.2022



GENERAL NOTE: 300mm VEHICLE CLEARANCE USED DUE TO LOW SPEED ENVIRONMENT

SERVICE VEHICLE MOVEMENTS TO BE UNDERTAKEN OUTSIDE OF PEAK TIMES WHEN NO VEHICLES ARE IN THE CAR STACKER QUEUING SPACES.

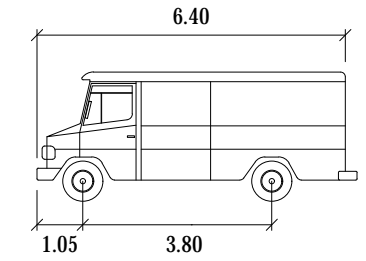
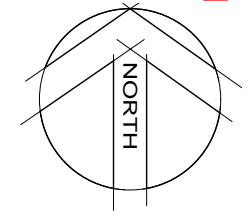
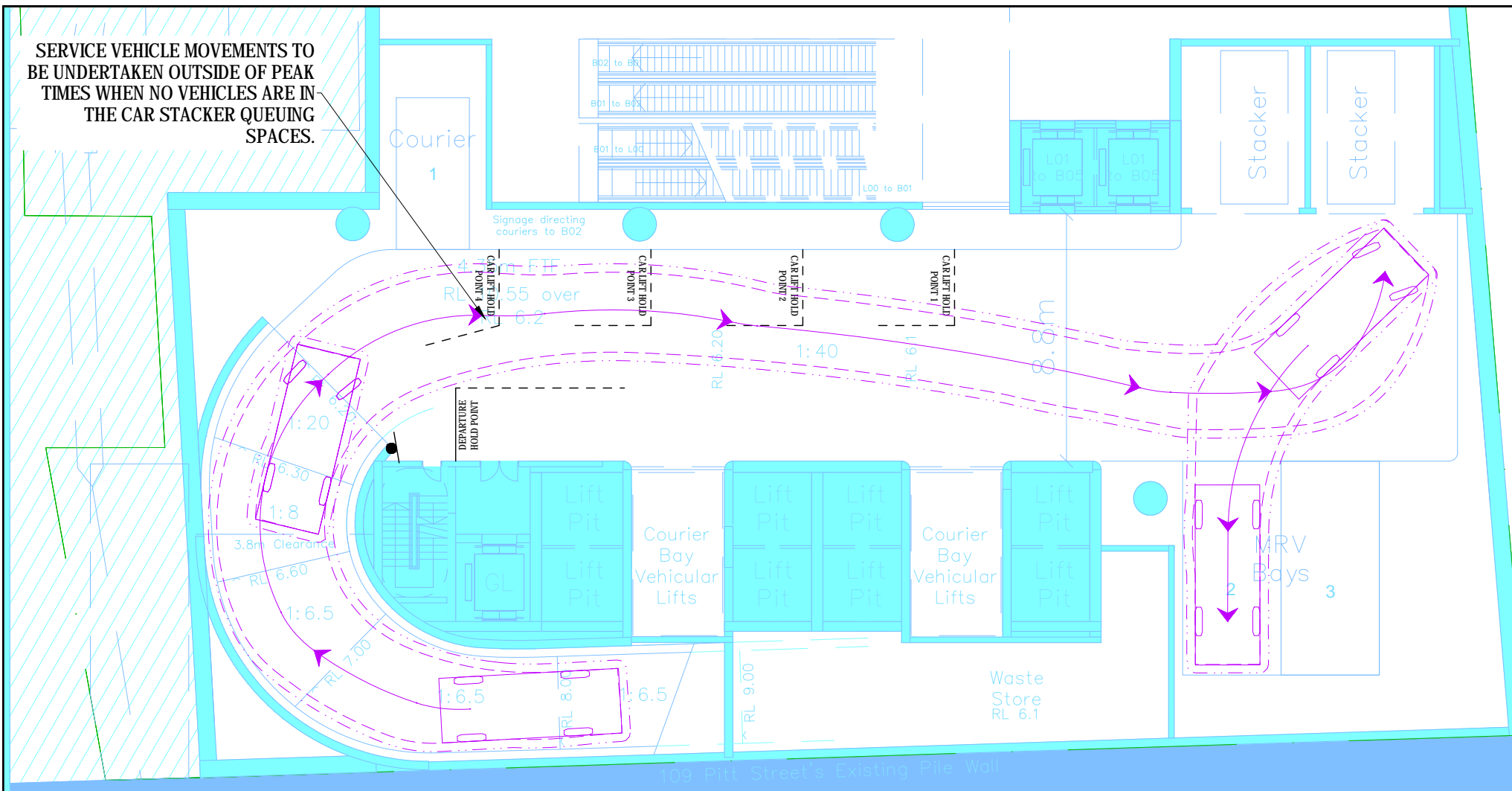

SRV	units
Width	: 2.30
Track	: 2.30
Lock to Lock Time	: 6.0
Steering Angle	: 38.0

SERVICE VEHICLE MOVEMENTS TO BE UNDERTAKEN OUTSIDE OF PEAK TIMES WHEN NO VEHICLES ARE IN THE CAR STACKER QUEUING SPACES.

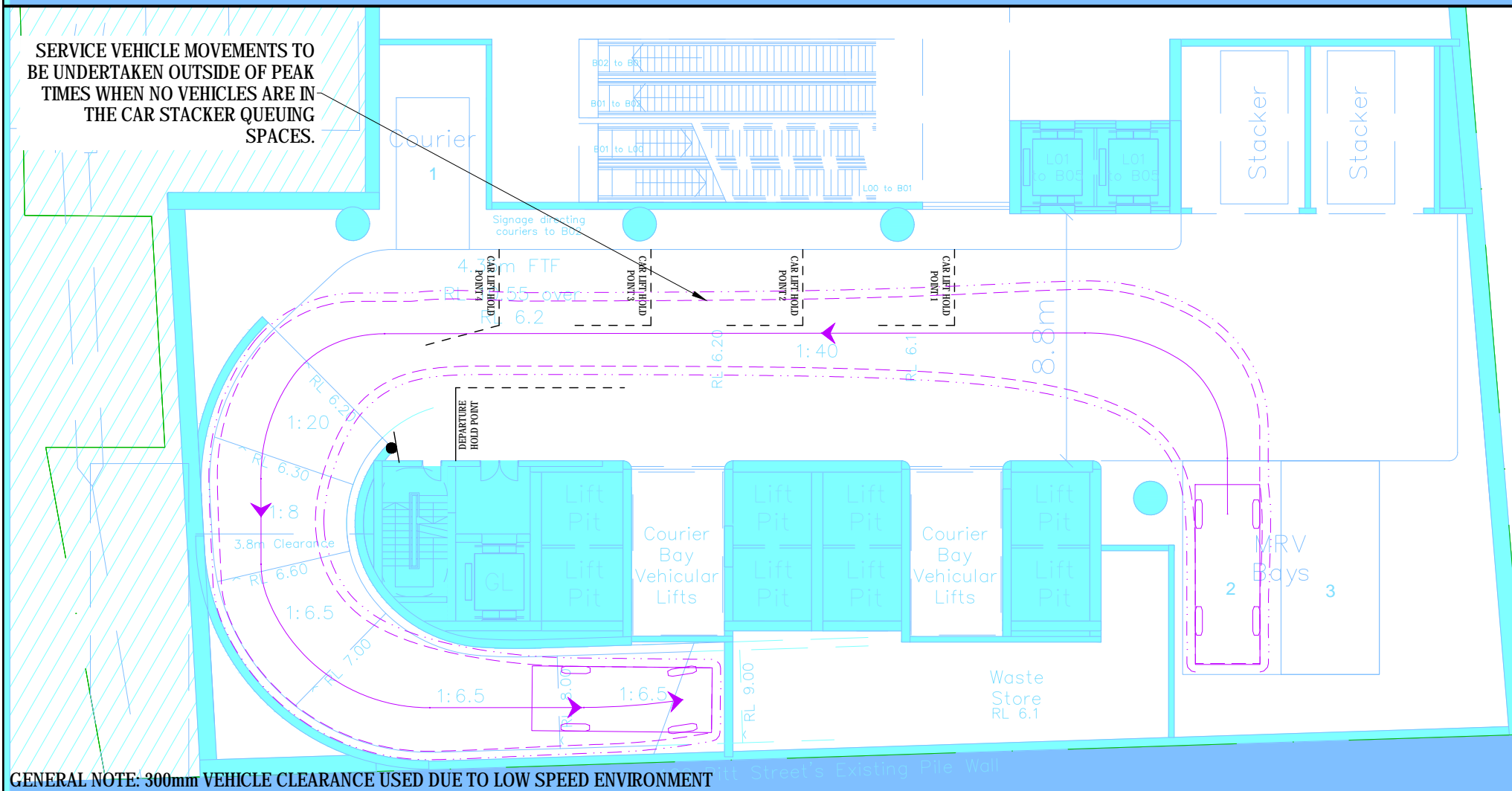

VEHICLE LEGEND

- 6.4m SRV 300mm CLEARANCE
- 6.4m SRV OVERHANG
- 6.4m SRV CENTRELINE

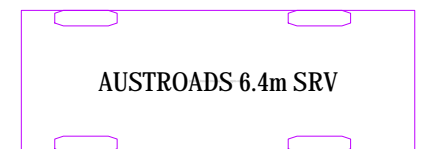

PS120302 SK048

BASEMENT LEVEL 1
6.4m SRV - SITE INGRESS/EGRESS 02

C.H. 10.02.2022



SCALE 1:200 @A3

GENERAL NOTE: 300mm VEHICLE CLEARANCE USED DUE TO LOW SPEED ENVIRONMENT

SERVICE VEHICLE MOVEMENTS TO BE UNDERTAKEN OUTSIDE OF PEAK TIMES WHEN NO VEHICLES ARE IN THE CAR STACKER QUEUING SPACES.

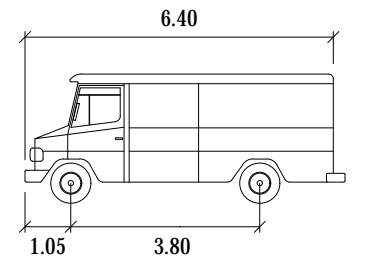
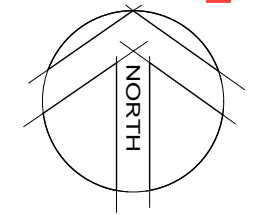
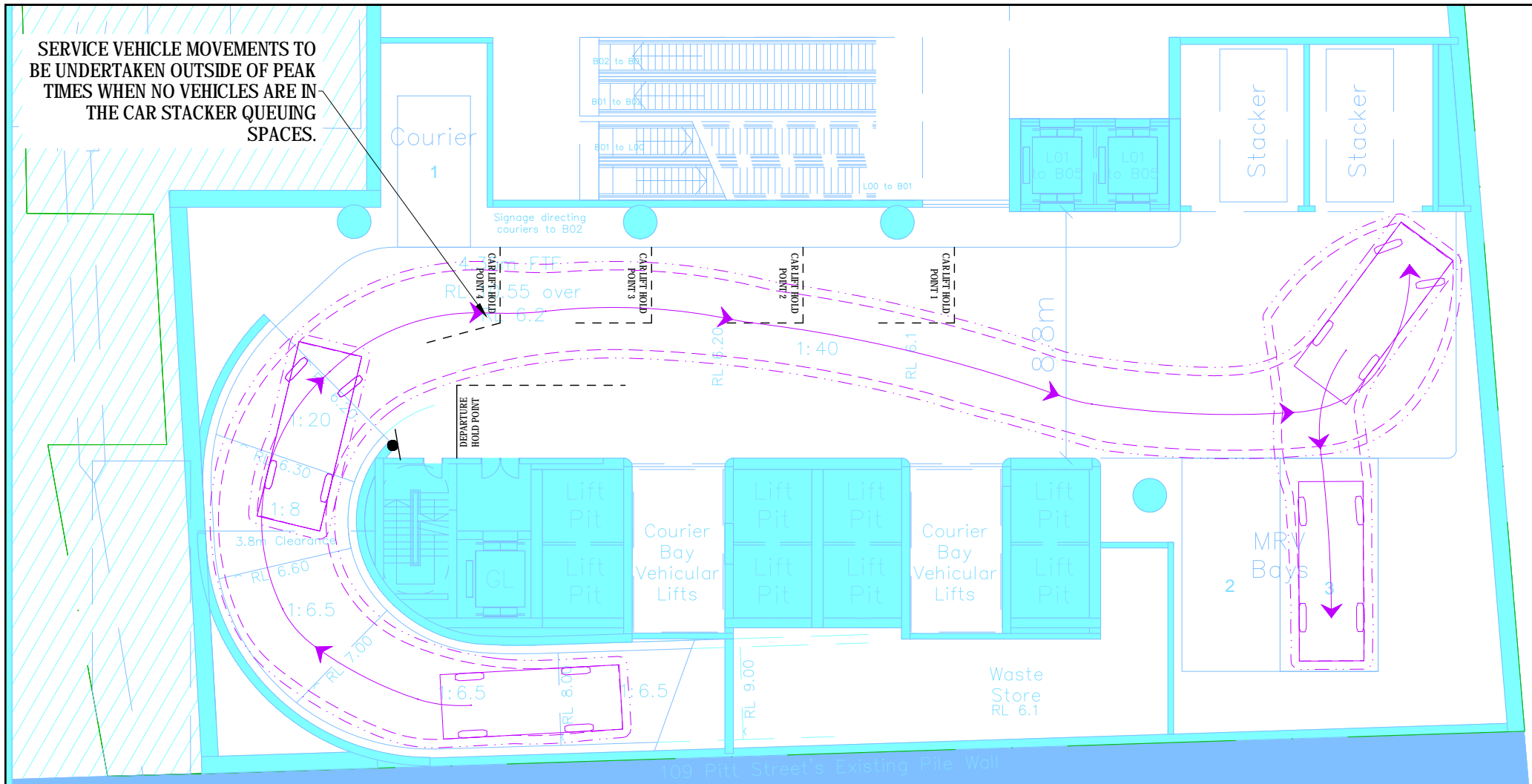

SRV	units
Width	: 2.30
Track	: 2.30
Lock to Lock Time	: 6.0
Steering Angle	: 38.0

SERVICE VEHICLE MOVEMENTS TO BE UNDERTAKEN OUTSIDE OF PEAK TIMES WHEN NO VEHICLES ARE IN THE CAR STACKER QUEUING SPACES.

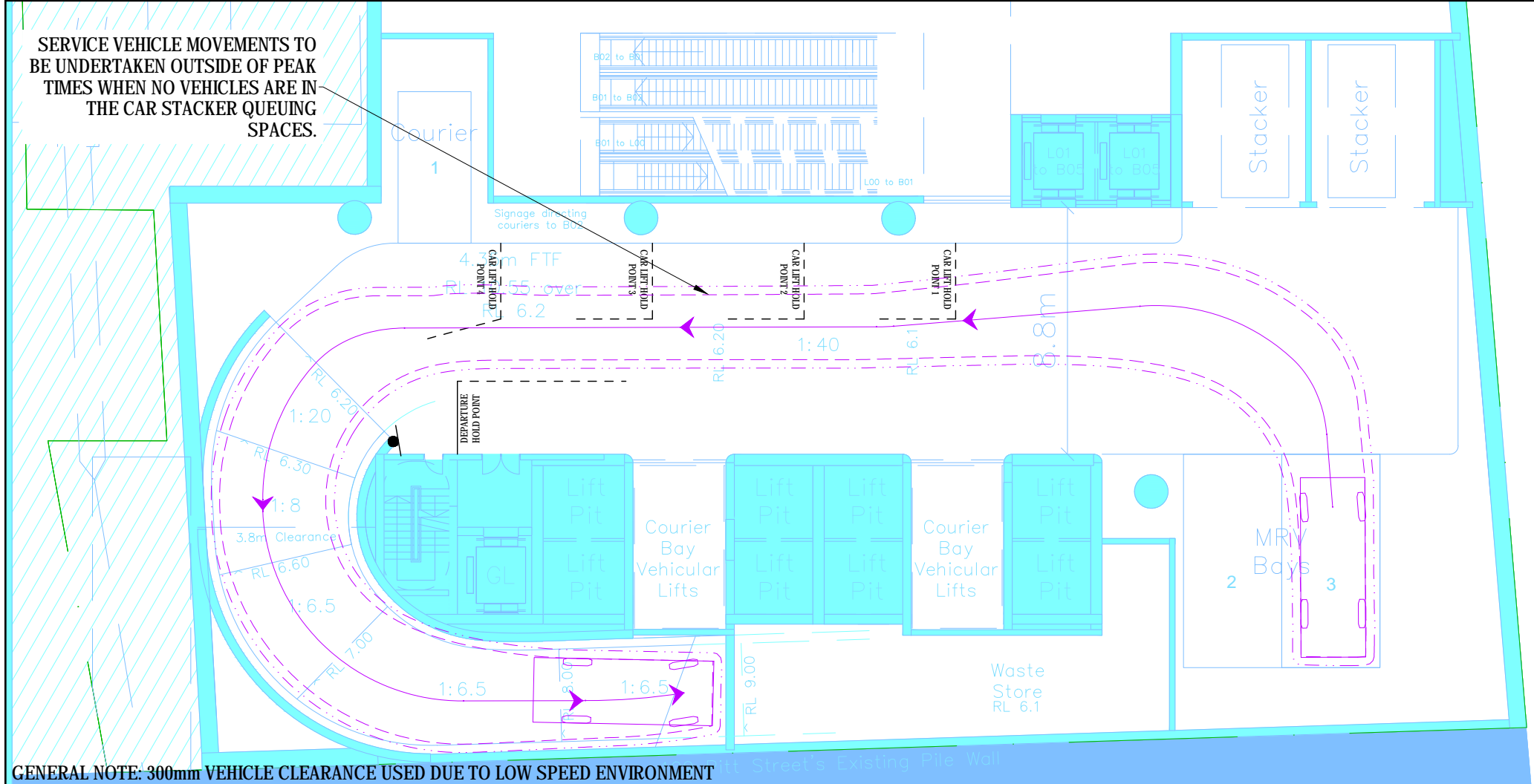

VEHICLE LEGEND

- 6.4m SRV 300mm CLEARANCE
- 6.4m SRV OVERHANG
- 6.4m SRV CENTRELINE

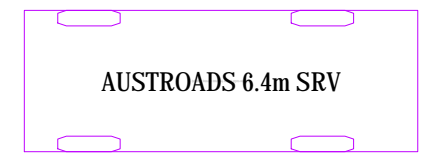

PS120302 SK049

BASEMENT LEVEL 1
6.4m SRV - SITE INGRESS/EGRESS 03

C.H. 10.02.2022



GENERAL NOTE: 300mm VEHICLE CLEARANCE USED DUE TO LOW SPEED ENVIRONMENT

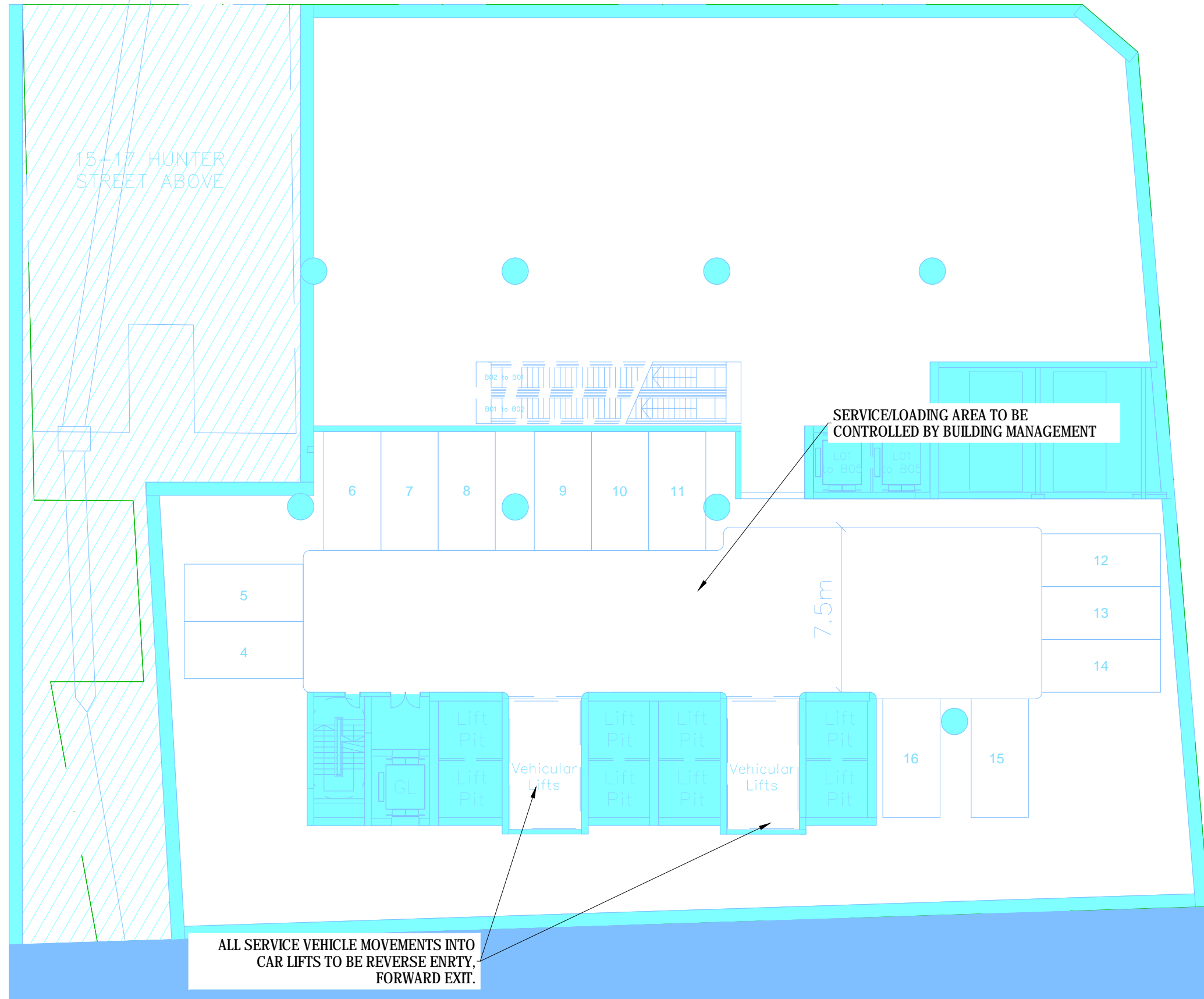
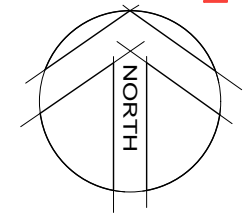

PS120302 SK050
BASEMENT LEVEL 2
GENERAL DESIGN COMMENTS

C.H. 10.02.2022

0 5 8m



SCALE 1:200

@A3

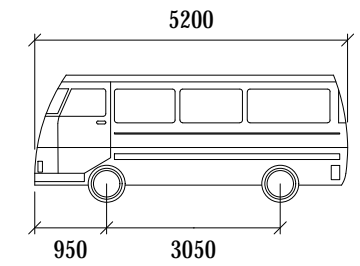
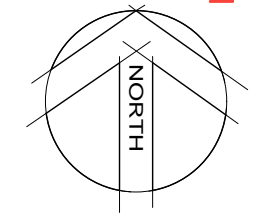

VAN	mm
Width	: 1940
Track	: 1840
Lock to Lock Time	: 6.0
Steering Angle	: 33.5

VEHICLE LEGEND

- 5.2m VAN 300mm CLEARANCE
- 5.2m VAN OVERHANG
- 5.2m VAN CENTRELINE



PS120302 SK051

**BASEMENT LEVEL 2
SERVICE VEHICLE INGRESS/EGRESS 01**

C.H. 10.02.2022

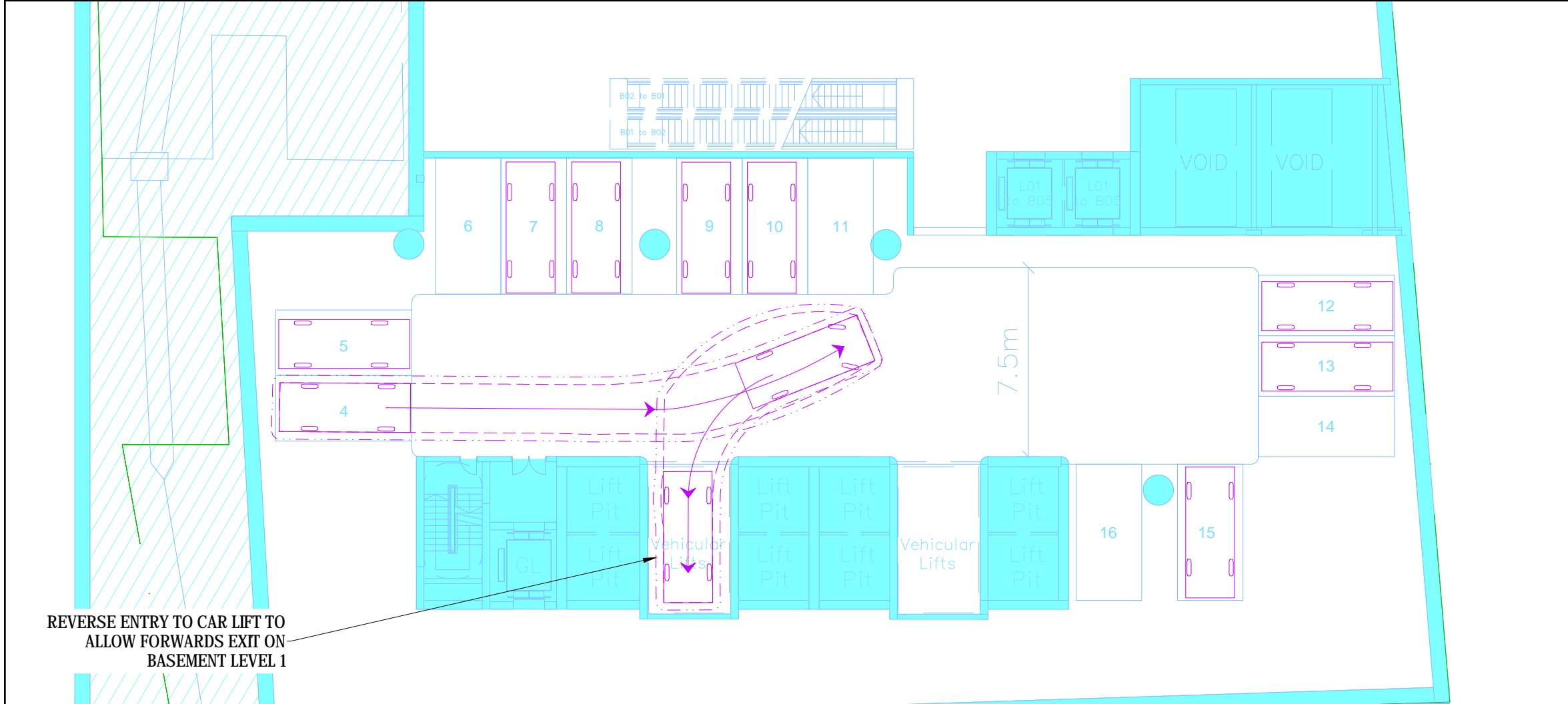
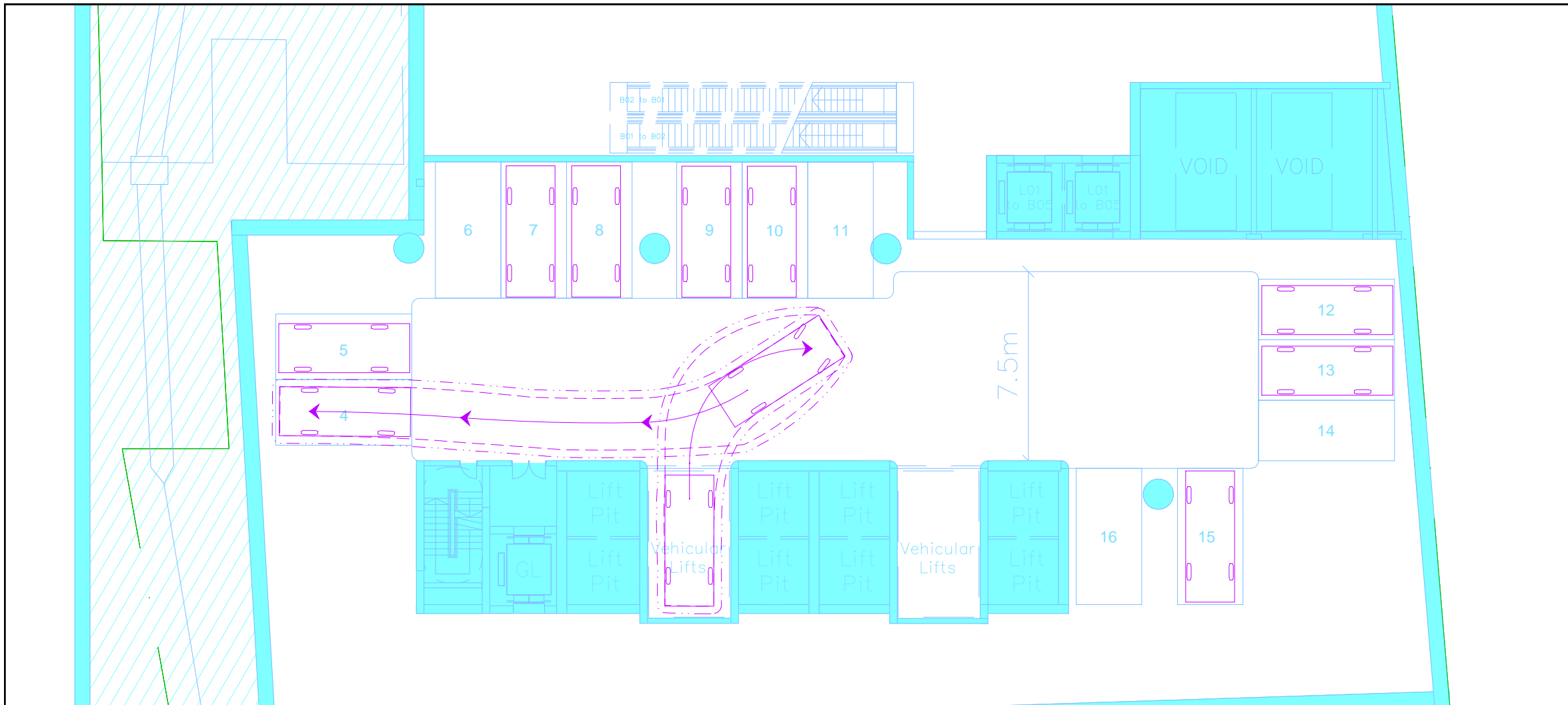

REVERSE ENTRY TO CAR LIFT TO
ALLOW FORWARDS EXIT ON
BASEMENT LEVEL 1

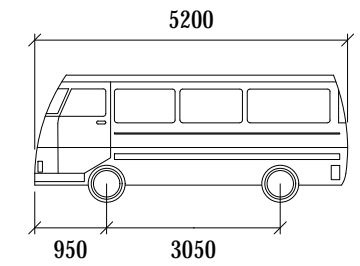
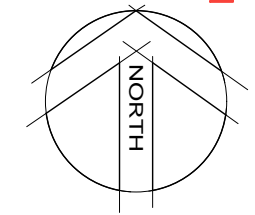

VAN	mm
Width	: 1940
Track	: 1840
Lock to Lock Time	: 6.0
Steering Angle	: 33.5

VEHICLE LEGEND

- 5.2m VAN 300mm CLEARANCE
- 5.2m VAN OVERHANG
- 5.2m VAN CENTRELINE

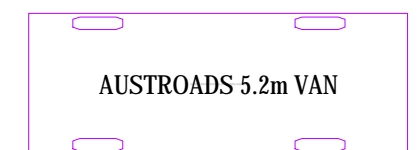

PS120302 SK052

**BASEMENT LEVEL 2
SERVICE VEHICLE INGRESS/EGRESS 02**

C.H. 10.02.2022

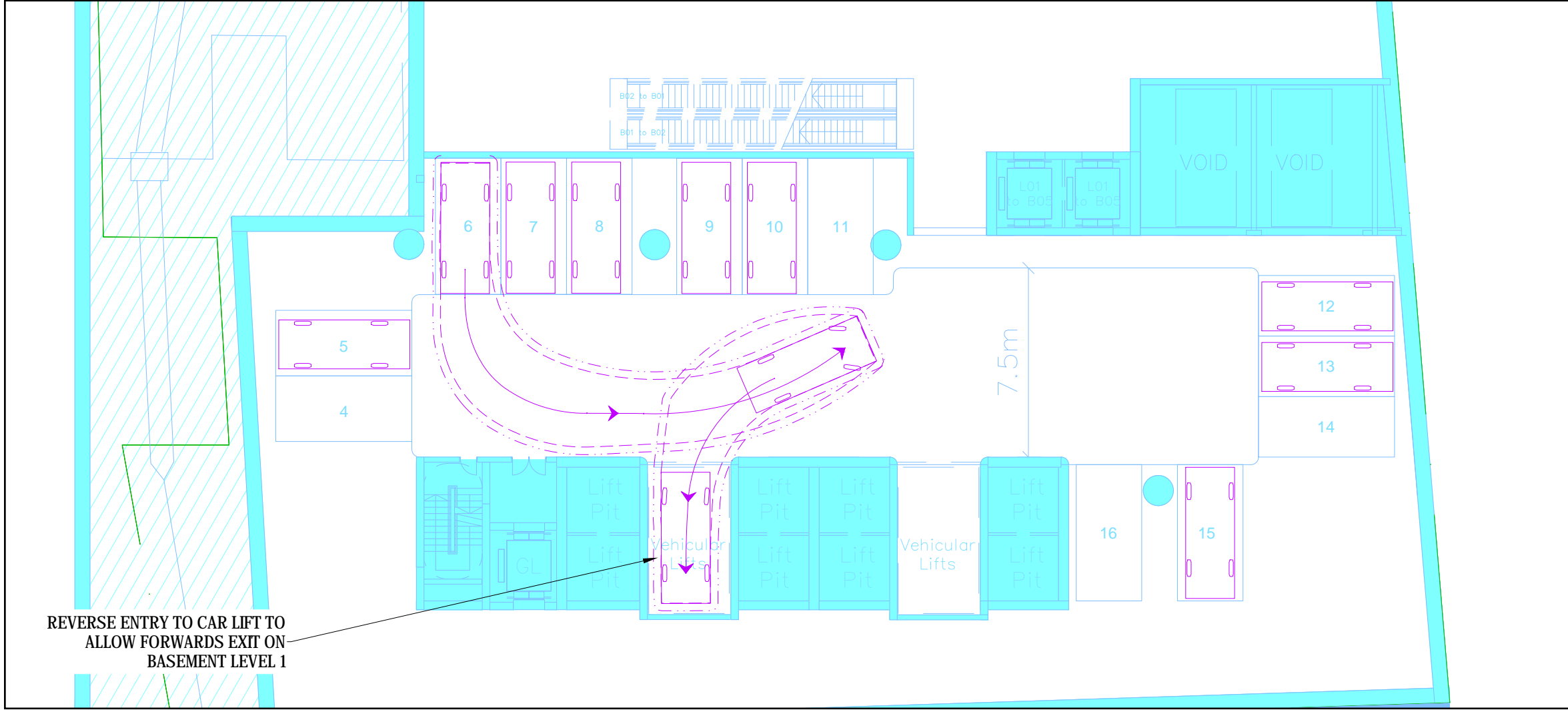
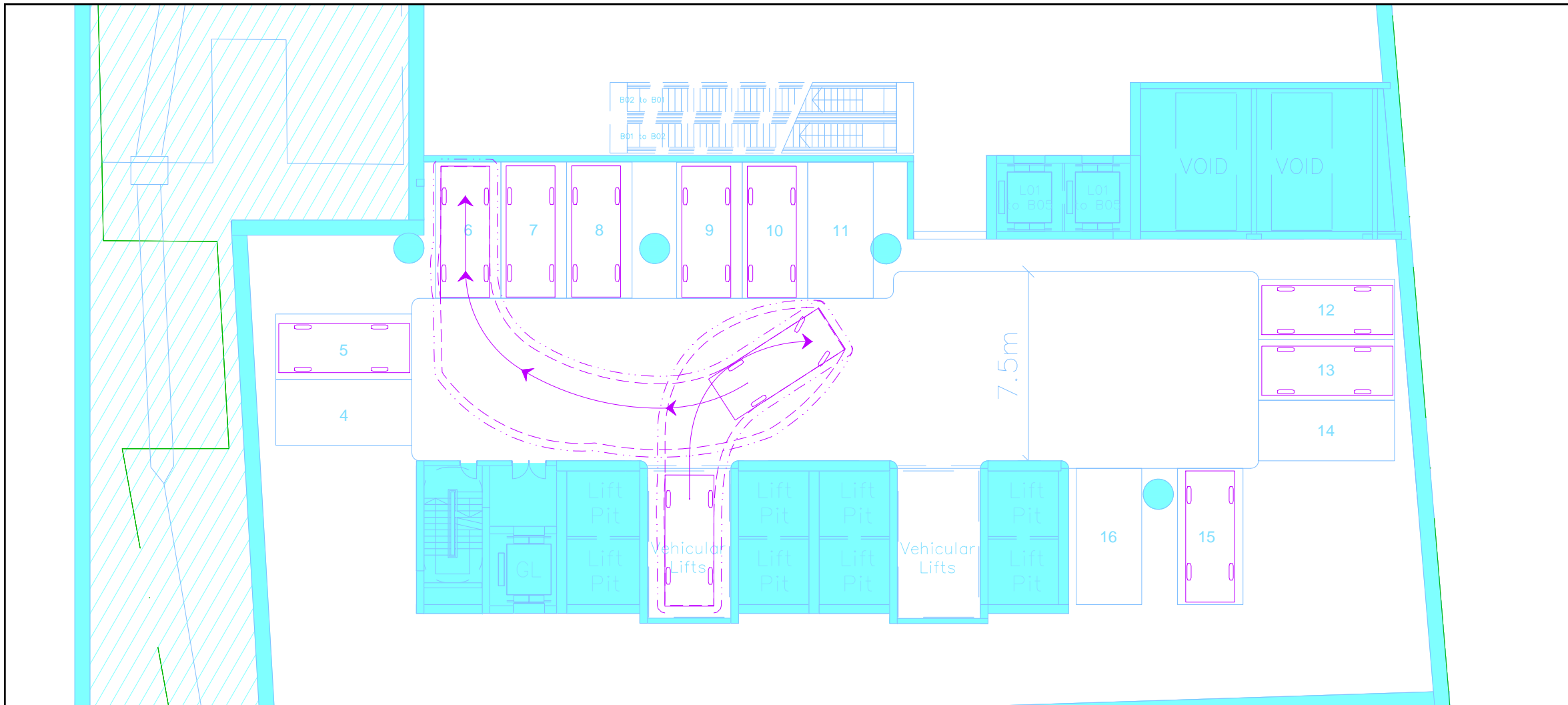

REVERSE ENTRY TO CAR LIFT TO
ALLOW FORWARDS EXIT ON
BASEMENT LEVEL 1

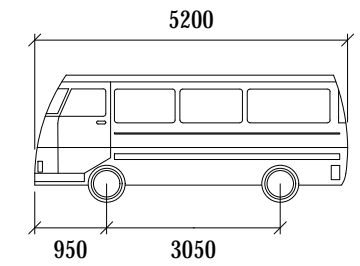
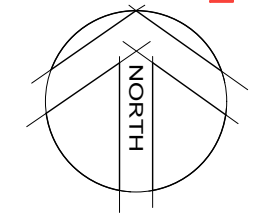

VAN	mm
Width	: 1940
Track	: 1840
Lock to Lock Time	: 6.0
Steering Angle	: 33.5

VEHICLE LEGEND

- 5.2m VAN 300mm CLEARANCE
- 5.2m VAN OVERHANG
- 5.2m VAN CENTRELINE



PS120302 SK053

**BASEMENT LEVEL 2
SERVICE VEHICLE INGRESS/EGRESS 03**

C.H. 10.02.2022

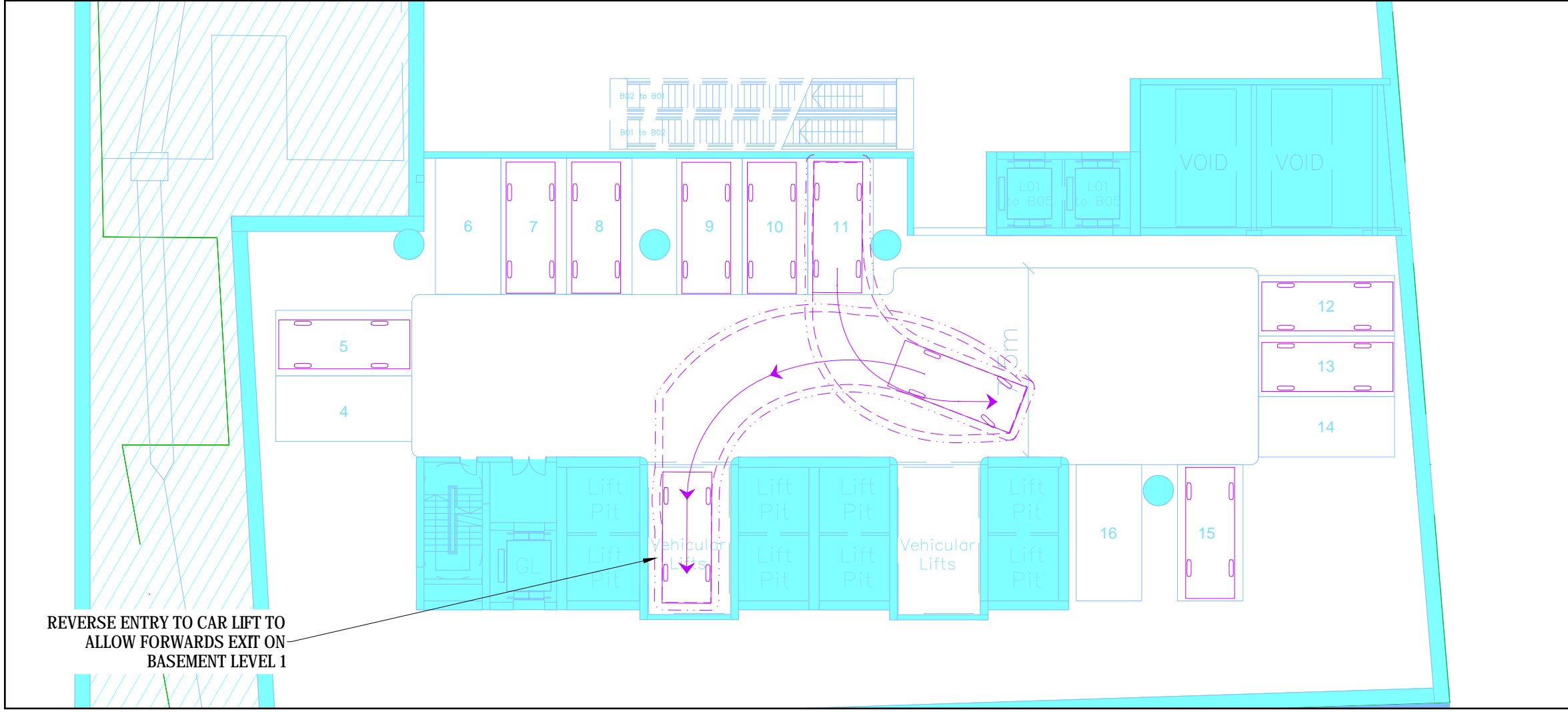
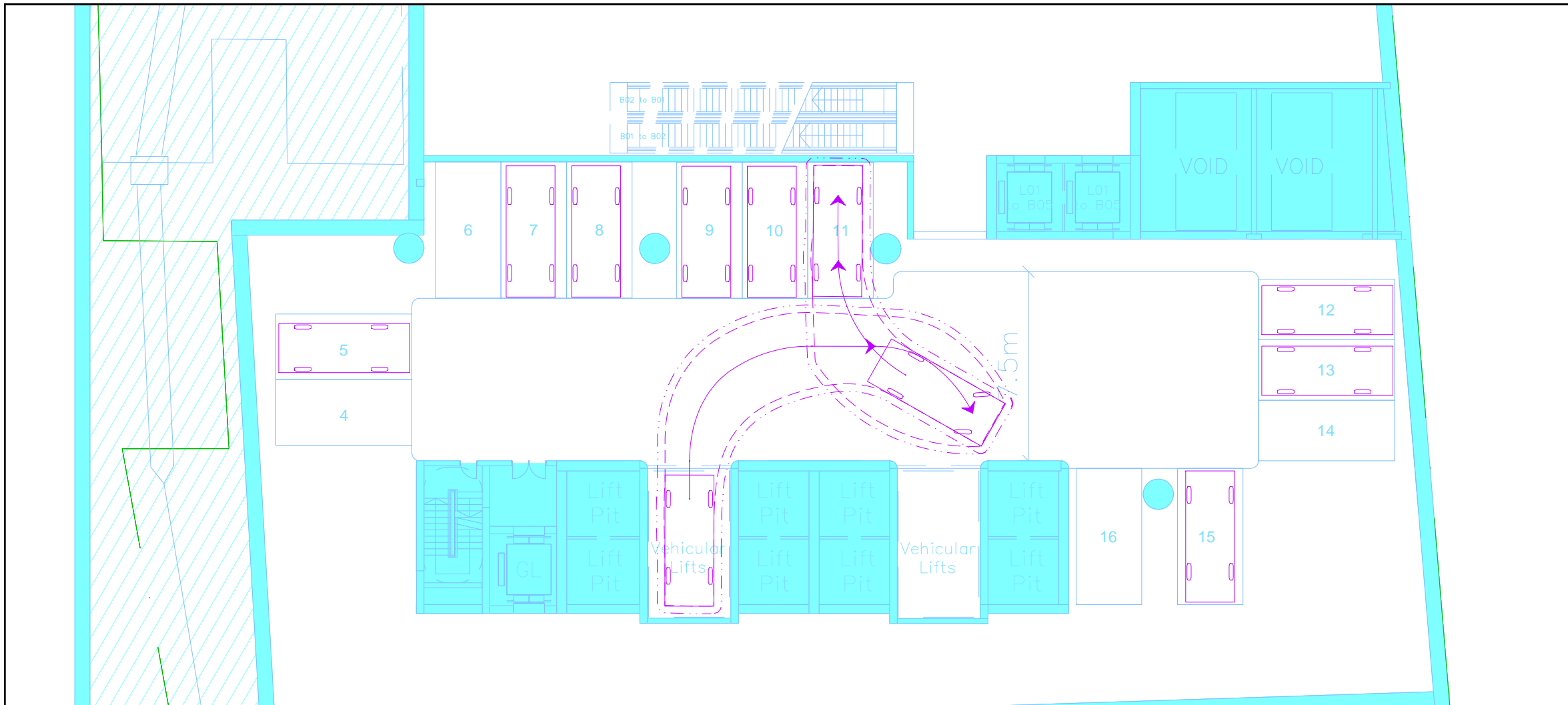

REVERSE ENTRY TO CAR LIFT TO
ALLOW FORWARDS EXIT ON
BASEMENT LEVEL 1

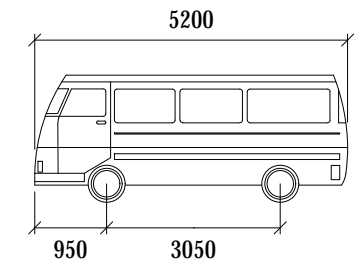
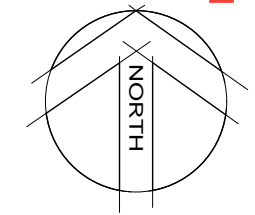

VAN	mm
Width	: 1940
Track	: 1840
Lock to Lock Time	: 6.0
Steering Angle	: 33.5

VEHICLE LEGEND

- 5.2m VAN 300mm CLEARANCE
- 5.2m VAN OVERHANG
- 5.2m VAN CENTRELINE

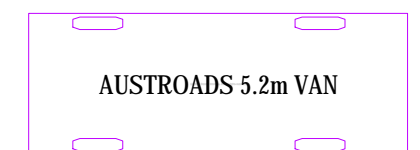

PS120302 SK054

**BASEMENT LEVEL 2
SERVICE VEHICLE INGRESS/EGRESS 04**

C.H. 10.02.2022



REVERSE ENTRY TO CAR LIFT TO
ALLOW FORWARDS EXIT ON
BASEMENT LEVEL 1

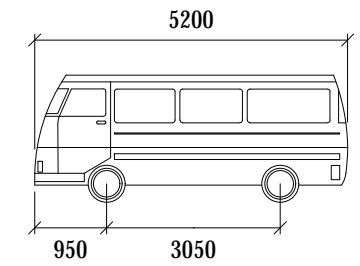
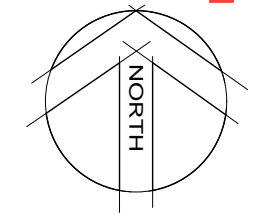

VAN	mm
Width	: 1940
Track	: 1840
Lock to Lock Time	: 6.0
Steering Angle	: 33.5

VEHICLE LEGEND

- 5.2m VAN 300mm CLEARANCE
- 5.2m VAN OVERHANG
- 5.2m VAN CENTRELINE

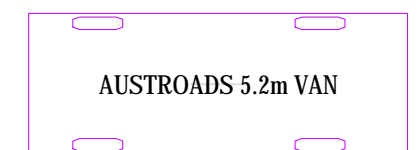

PS120302 SK055

**BASEMENT LEVEL 2
SERVICE VEHICLE INGRESS/EGRESS 05**

C.H. 10.02.2022



REVERSE ENTRY TO CAR LIFT TO
ALLOW FORWARDS EXIT ON
BASEMENT LEVEL 1

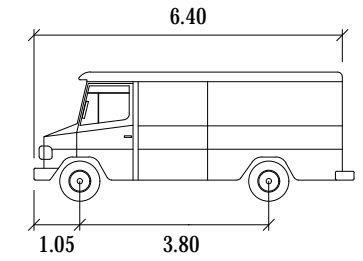
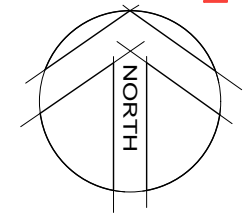

SRV	units
Width	: 2.30
Track	: 2.30
Lock to Lock Time	: 6.0
Steering Angle	: 38.0
Front Clearance	: 0.15
Wheelbase Clearance	: 0.17
Rear Clearance	: 0.15

VEHICLE LEGEND

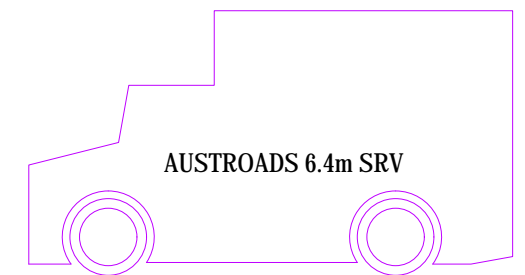

PS120302 SK056
GROUND LEVEL TO BASEMENT
VERTICAL CLEARANCE CHECK

C.H. 10.02.2022

0 5 8m



SCALE 1:200 @A3

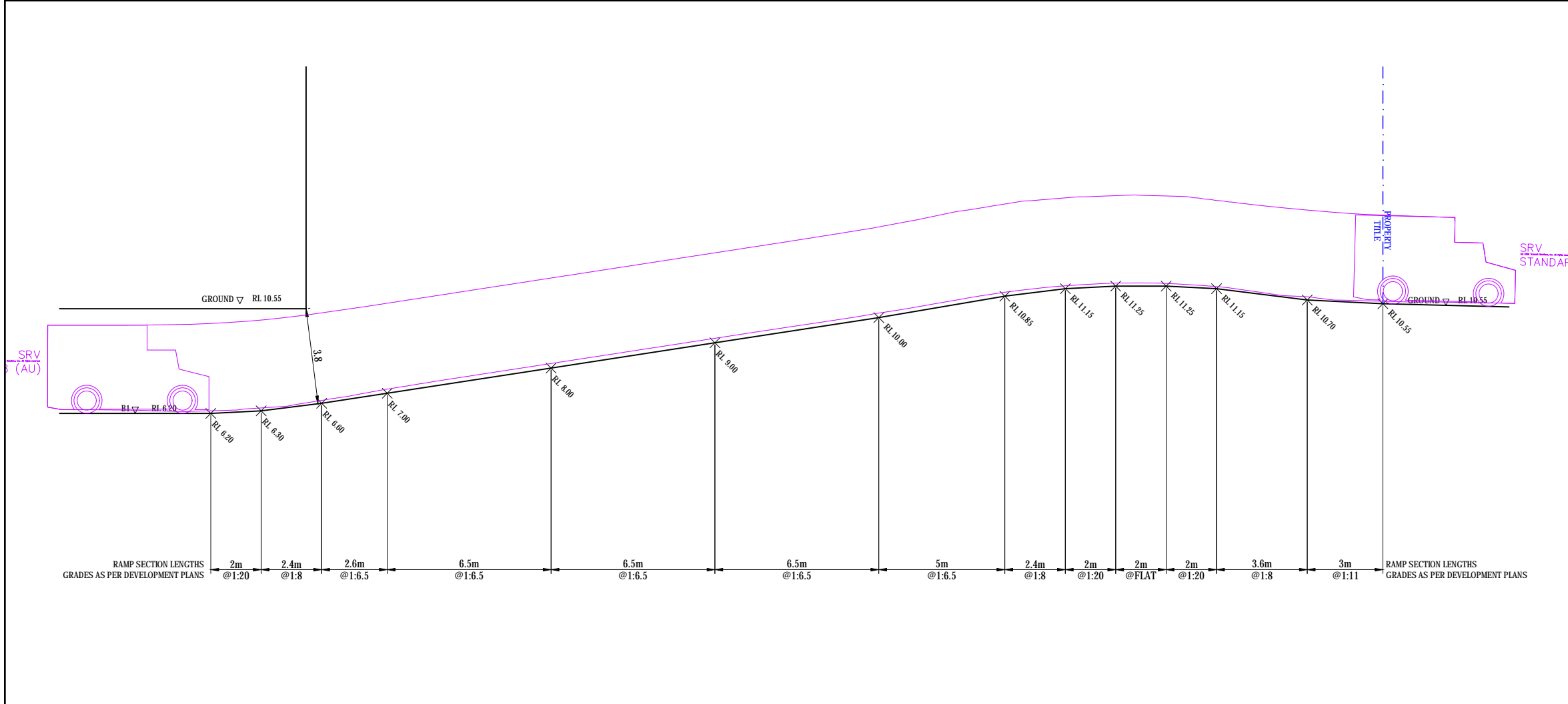
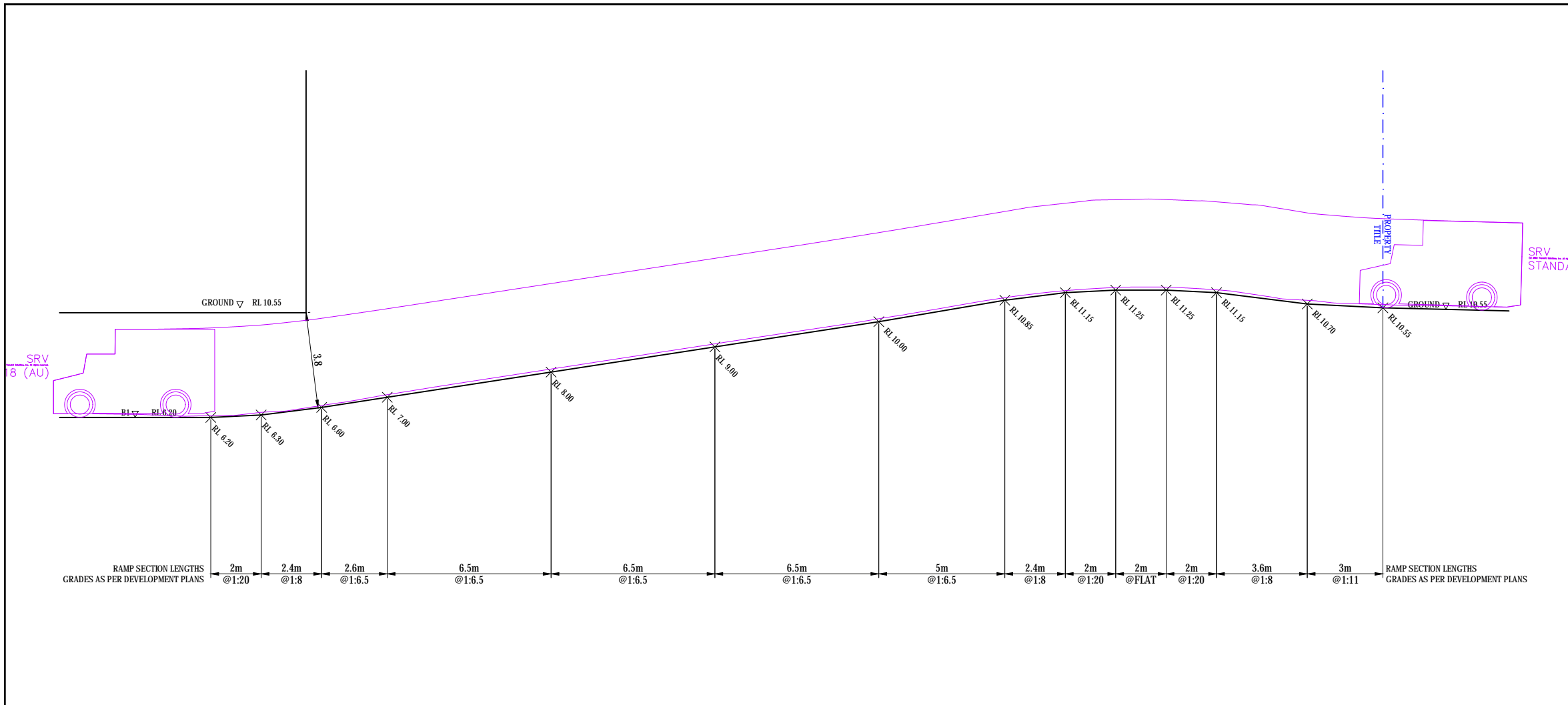

APPENDIX C

MECHANICAL CAR STACKER AND CAR
LIFT SPECIFICATIONS



Data Sheet

WÖHR MULTIPARKER 710/720/730



Please observe the separate Technical Notes!



The Multiparker utilizes clever and smart the available surface and provides parking space with different variants.

- As tower and/or pit version
- Automatically operated parking systems for 10 to more than 100 cars
- Variable system length available
- Multiple row arrangement with up to 2 parking rows behind each other
- Well adaptable to individual project requirements
- Safe for user and cars (no narrow ramps, dark stairs, no damage caused by theft or vandalism)
- Customizable arrangement of transfer area
- Very fast access time by use of a quick-change pallet system
- No ramps and driving lanes
- No costly illumination and ventilation necessary
- Different car heights possible, e.g. Vans, SUVs
- For car weight up to 2.5 t, higher loads are possible after consultation with WÖHR
- Easy operation with several control options, e.g. transponder chip or remote control
- Suitable for apartment- and office buildings and for public parking
- Following the idea of "Green Parking"

Multiparker 710 | Tower system for 2-8 parking levels

- Parking system for 2-8 parking levels as tower variant
- Linear expansion variable (see dimension D on table below)
- Variable arrangement of transfer area (see page 8)

- Vehicles of various height can be parked thanks to parking levels of various height
- Multi-row arrangement (see page 8)
- Quick-change pallet system = short access times
- Integrated turning device possible (option)

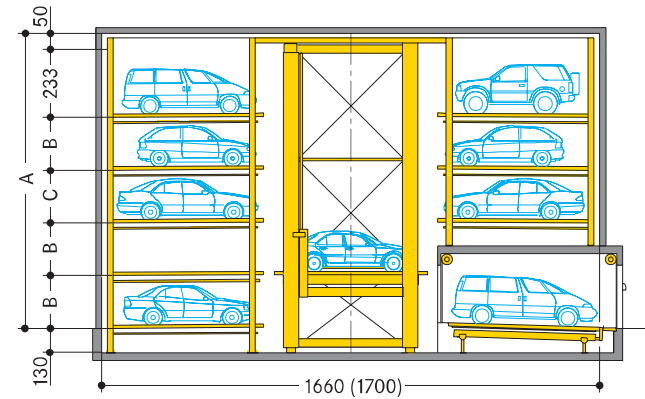

Transfer area (dimensions without turning device)

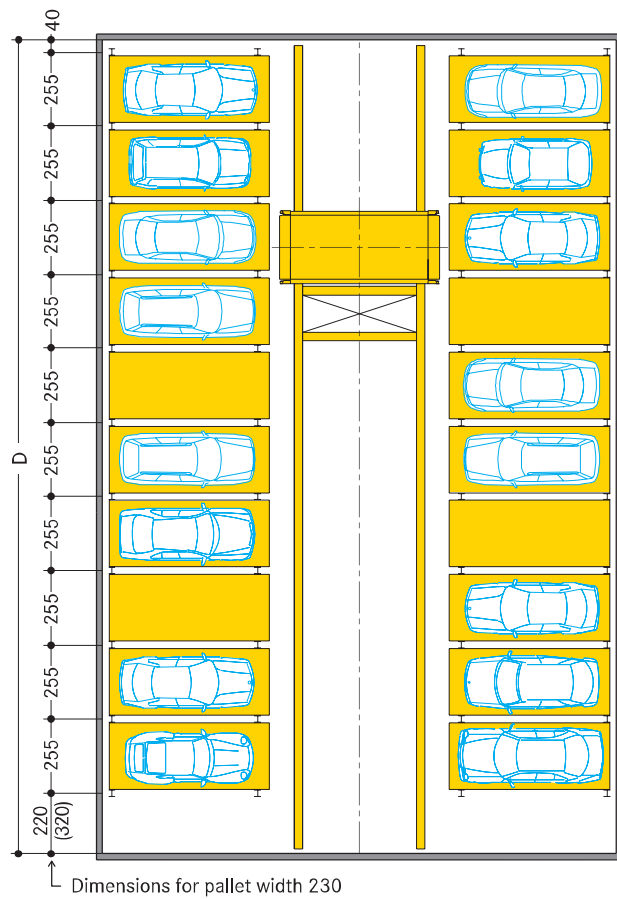
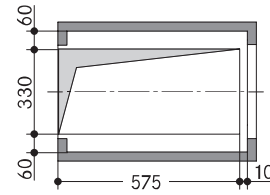

Parking levels	Dimension A for 160 cm high cars	Dimension A for 200 cm high cars
2	476	516
3	689	769
4	882	1002
5	1075	1235
6	1288	1488
7	1481	1721
8	1674	1954

Car height	Dimension B	Dimension C
160	193	213
185	218	238
200	233	253

Parking places per level*	Pallet width 230 Grid width 255 cm Length D
12	1790
14	2045
16	2300
18	2555
20	2810
22	3065
24	3320
26	3555
28	3830
30	4085
32	4340
34	4595
36	4850
38	5105
40	5360

* The number of parking places depends on number and arrangement of transfer areas

() Dimensions in brackets for storage and retrieval unit with turning device

Dimensions in cm

For the control unit, space (at least length 500 cm x width 200 cm x height 240 cm) must be available near the transfer area.

Multiparker 710 | Shaft system for 2-8 parking levels

- Parking system for 2-8 parking levels as shaft variant
- Linear expansion variable (see dimension D on table below)
- Variable arrangement of transfer area (see page 8)
- Vehicles of various height can be parked thanks to parking levels of various height
- Multi-row arrangement (see page 8)
- Quick-change pallet system = short access times
- Integrated turning device possible (option)

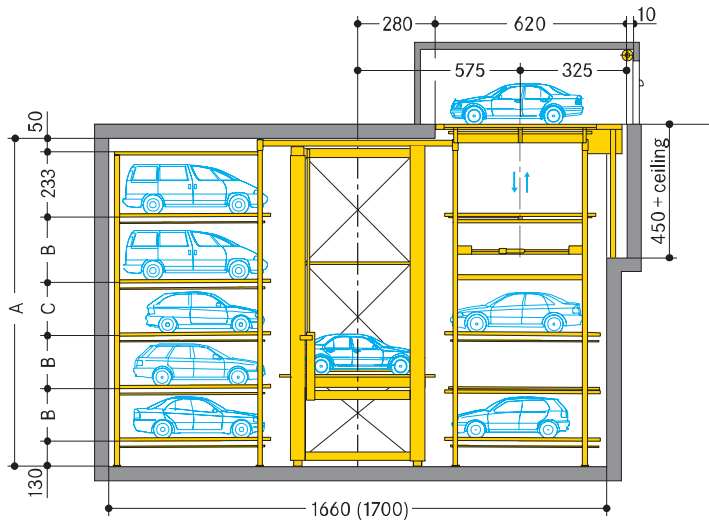

Transfer area (dimensions without turning device)

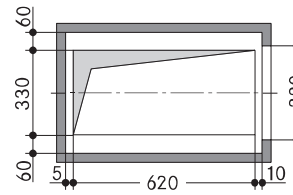

Parking levels	Dimension A for 160 cm high cars	Dimension A for 200 cm high cars
2	606	646
3	819	899
4	1012	1132
5	1205	1365
6	1418	1618
7	1611	1851
8	1804	2084

Car height	Dimension B	Dimension C
160	193	213
185	218	238
200	233	253

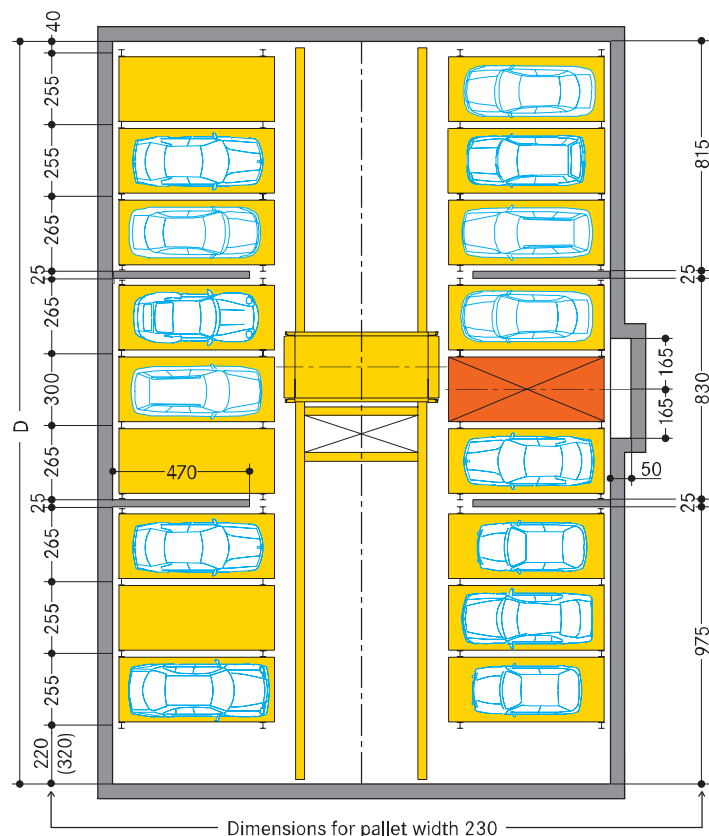

Parking places per level*	Pallet width 230 Grid width 255 cm Length D**
12	1880
14	2180
16	2435
18	2690
20	2990
22	3245
24	3500
26	3800
28	4055
30	4310
32	4610
34	4865
36	5120
38	5420
40	5675
42	5930

* The number of parking places depends on number and arrangement of lifts
 ** All specified dimensions of length D are examples only and depend on width and number of partitions walls

Dimensions in cm

() Dimensions in brackets for storage and retrieval unit with turning device

For the control unit, space (at least length 500 cm x width 200 cm x height 240 cm) must be available near the transfer area.

Multiparker 720 | Tower system for 4–20 parking levels

- Parking system for 4–20 parking levels as tower variant
- Linear expansion limited to max. 6 parking bays per row
- Variable arrangement of transfer area (see page 8)

- Vehicles of various height can be parked thanks to parking levels of various height
- Multi-row arrangement (see page 8)
- Quick-change pallet system = short access times
- Integrated turning device possible (option)

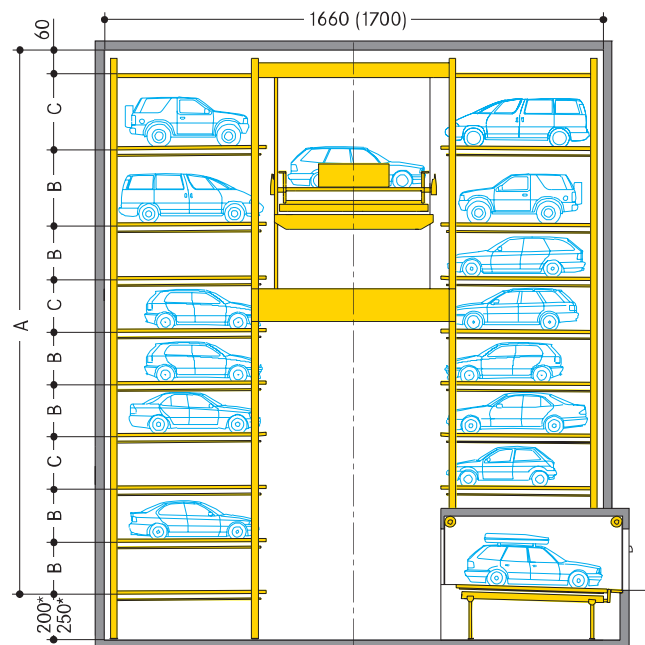

Transfer area (dimensions without turning device)

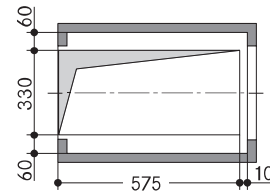

* Dimension 200 cm apply to 4 or 8 parking places per level
Dimension 250 cm apply to 10 or 12 parking places per level

() Dimensions in brackets for storage and retrieval unit with turning device

Parking levels	Dimension A for 160 cm high cars	Dimension A for 200 cm high cars
4	852	1012
5	1045	1245
6	1258	1498
7	1451	1731
8	1644	1964
9	1857	2217
10	2050	2450
11	2243	2683
12	2456	2936
13	2649	3169
14	2842	3402
15	3055	3655
16	3248	3888
17	3441	4121
18	3654	4374
19	3847	4607
20	4040	4840

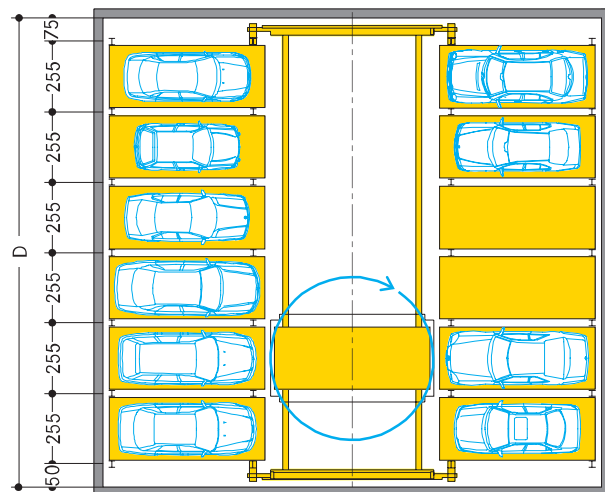

Dimensions for pallet width 230

Car height	Dimension B	Dimension C
160	193	213
185	218	238
200	233	253

Parking places per level**	Pallet width 230 Grid width 255 cm Length D
6	890
8	1145
10	1400
max. 12	1655

** The number of parking places depends on number and arrangement of transfer areas

Dimensions in cm

For the control unit, space (at least length 500 cm x width 200 cm x height 240 cm) must be available near the transfer area.

Multiparker 720 | Shaft system

- Linear expansion limited to max. 6 parking bays per row
- Variable arrangement of transfer area (see page 8)
- Vehicles of various height can be parked thanks to parking levels of various height

- Multi-row arrangement (see page 8)
- Quick-change pallet system = short access times
- Integrated turning device possible (option)

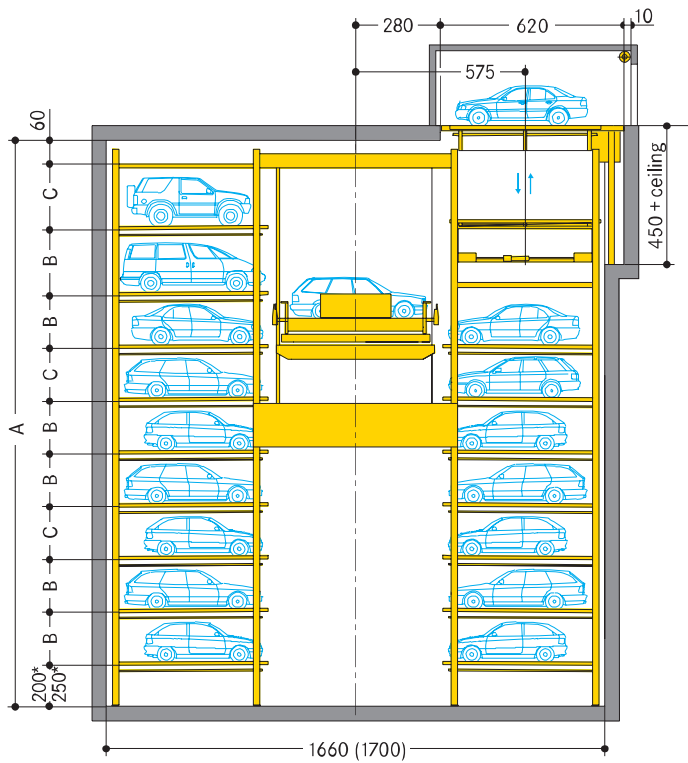

Transfer area (dimensions without turning device)

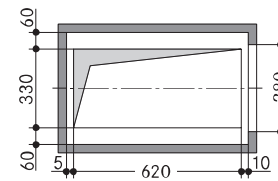

Parking levels	Dimension A** for 160 cm high cars	Dimension A** for 200 cm high cars
1	453	493
2	646	726
3	859	979
4	1052	1212
5	1245	1445
6	1458	1698
7	1651	1931
8	1844	2164
9	2057	2417
10	2250	2650
11	2443	2883
12	2656	3136

** All mentioned dimensions apply to 6 or 8 parking places per level. If 10 or 12 parking places per level are planned, these dimensions are to be increased by 50 cm.

* Dimension 200 cm apply to 6 or 8 parking places per level
Dimension 250 cm apply to 10 or 12 parking places per level

() Dimensions in brackets for storage and retrieval unit with turning device

Car height	Dimension B	Dimension C
160	193	213
185	218	238
200	233	253

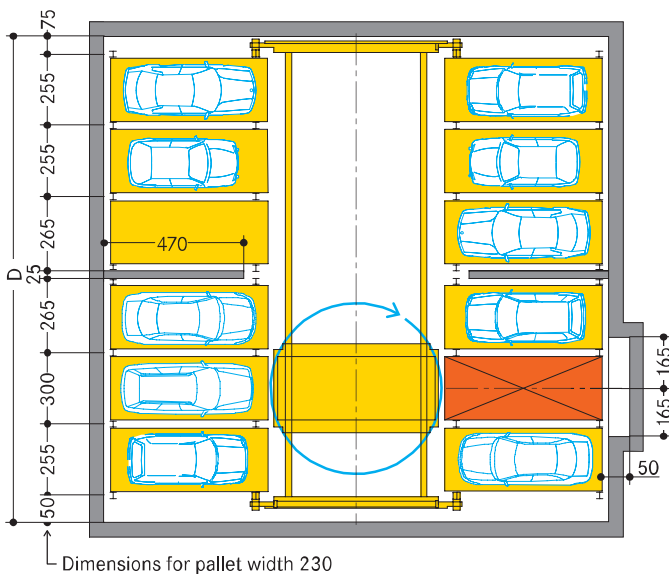

Parking places per level***	Pallet width 230 Length D****
6	935
8	1235
10	1490
max. 12	1745

*** The number of parking places depends on number and arrangement of transfer areas

**** All specified dimensions of length D are examples only and depend on width and number of partitions walls

Dimensions in cm

For the control unit, space (at least length 500 cm x width 200 cm x height 240 cm) must be available near the transfer area.

Multiparker 730 | Shuttle/Lift system with steel structure

- Parking system for a high number of parking spaces and a high throughput
- Separate shuttle in each parking level
- Each parking level connected with entrance/exit level by lifting unit
- Linear expansion variable (see dimension D on table below)
- Vehicles of various height can be parked thanks to parking levels of various height
- Multi-row arrangement (see page 8)
- Quick-change pallet system = short access times
- Integrated turning device in the transfer area possible (option)

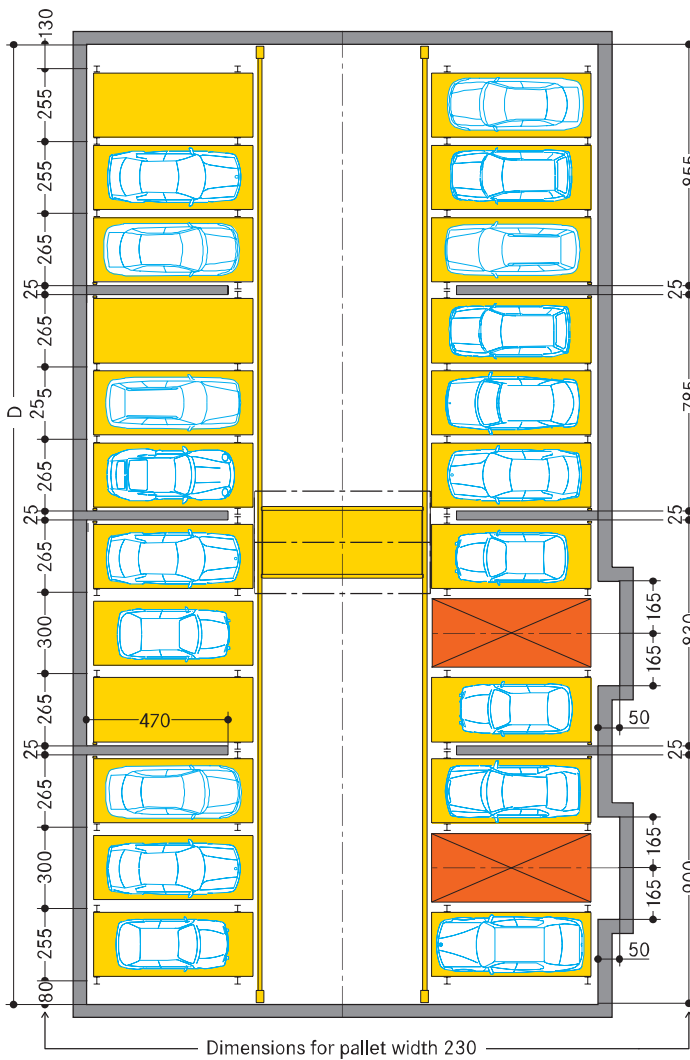
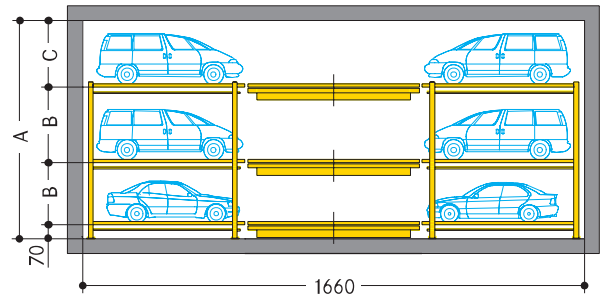
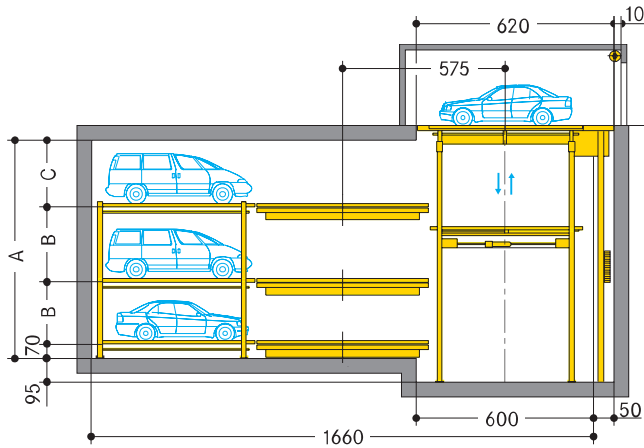

Transfer area (dimensions without turning device)

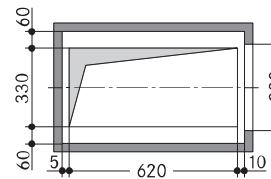

Parking levels	Dimension A for 160 cm high cars	Dimension A for 200 cm high cars
2	465	545
3	690	810
4	915	1075
5	1140	1340

Car height	Dimension B	Dimension C
160	225	170
185	250	195
200	265	210

Parking places per level*	Pallet width 230 Length D**
22	3495
24	3795
26	4050
28	4305
30	4605
32	4860
34	5115
36	5415
38	5670
40	5925
42	6225
44	6480
46	6735
48	7035
50	7290

For the control unit, space (at least length 500 cm x width 200 cm x height 240 cm) must be available near the transfer area.

* The number of parking places depends on number and arrangement of the lift

** All specified dimensions of length D are examples only and depend on width, number of partitions walls and number of lifts

Dimensions in cm

Multiparker 730 | Shuttle/Lift system with intermediate ceiling

- Parking system for a high number of parking spaces and a high throughput
- Separate shuttle in each parking level
- Each parking level connected with entrance/exit level by lifting unit
- Linear expansion variable (see dimension D on table below)
- Vehicles of various height can be parked thanks to parking levels of various height
- Multi-row arrangement (see page 8)
- Quick-change pallet system = short access times
- Integrated turning device in the transfer area possible (option)

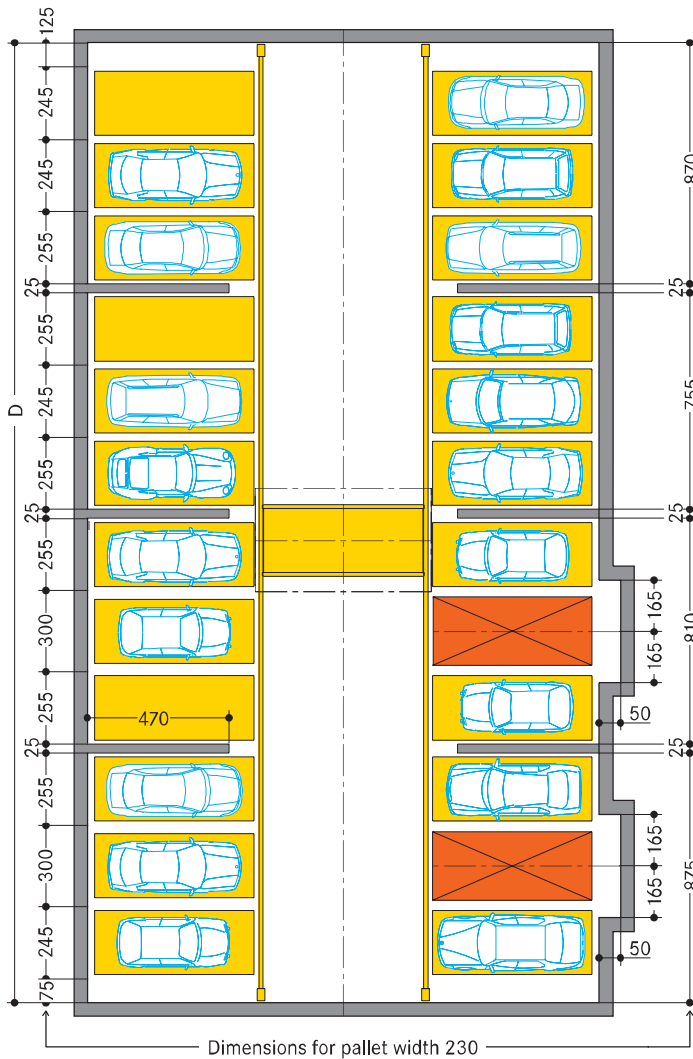
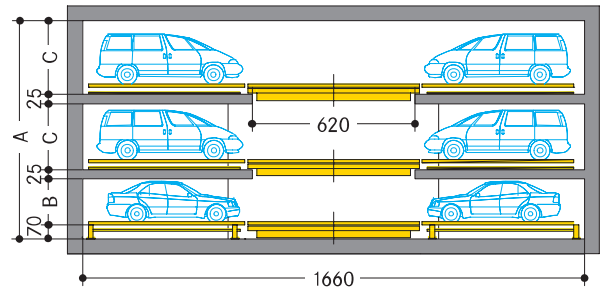
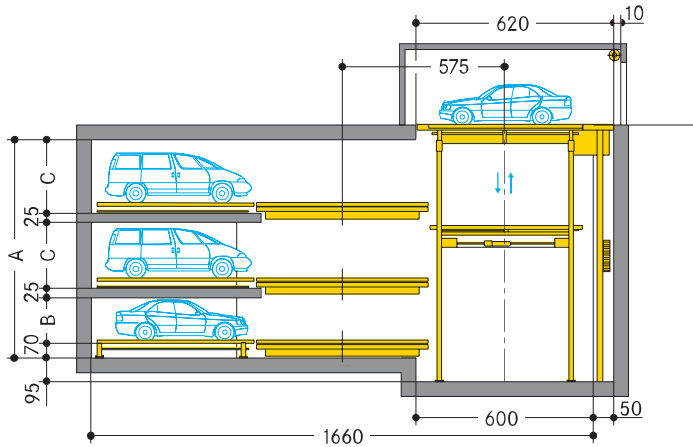

Transfer area (dimensions without turning device)

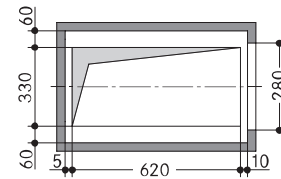

Parking levels	Dimension A for 160 cm high cars	Dimension A for 200 cm high cars
2	471	551
3	704	824
4	937	1097
5	1170	1370

Car height	Dimension B	Dimension C
160	168	208
185	193	233
200	208	248

Parking places per level*	Pallet width 230 Length D**
22	3385
24	3675
26	3920
28	4165
30	4455
32	4700
34	4945
36	5235
38	5480
40	5725
42	6015
44	6260
46	6505
48	6795
50	7040

For the control unit, space (at least length 500 cm x width 200 cm x height 240 cm) must be available near the transfer area.

* The number of parking places depends on number and arrangement of the lift

** All specified dimensions of length D are examples only and depend on width, number of partitions walls and number of lifts

Dimensions in cm

Multi-row arrangement

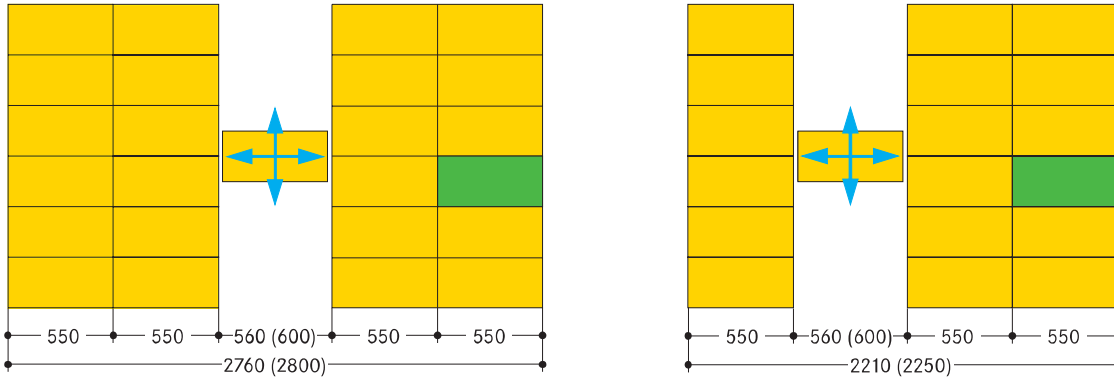

The multi-row arrangement allows an optimum utilisation of the available space and/or land area and saves civil engineering costs, particularly with the shaft variant.

() Dimensions in brackets for storage and retrieval unit with turning device

Possible arrangements of transfer area

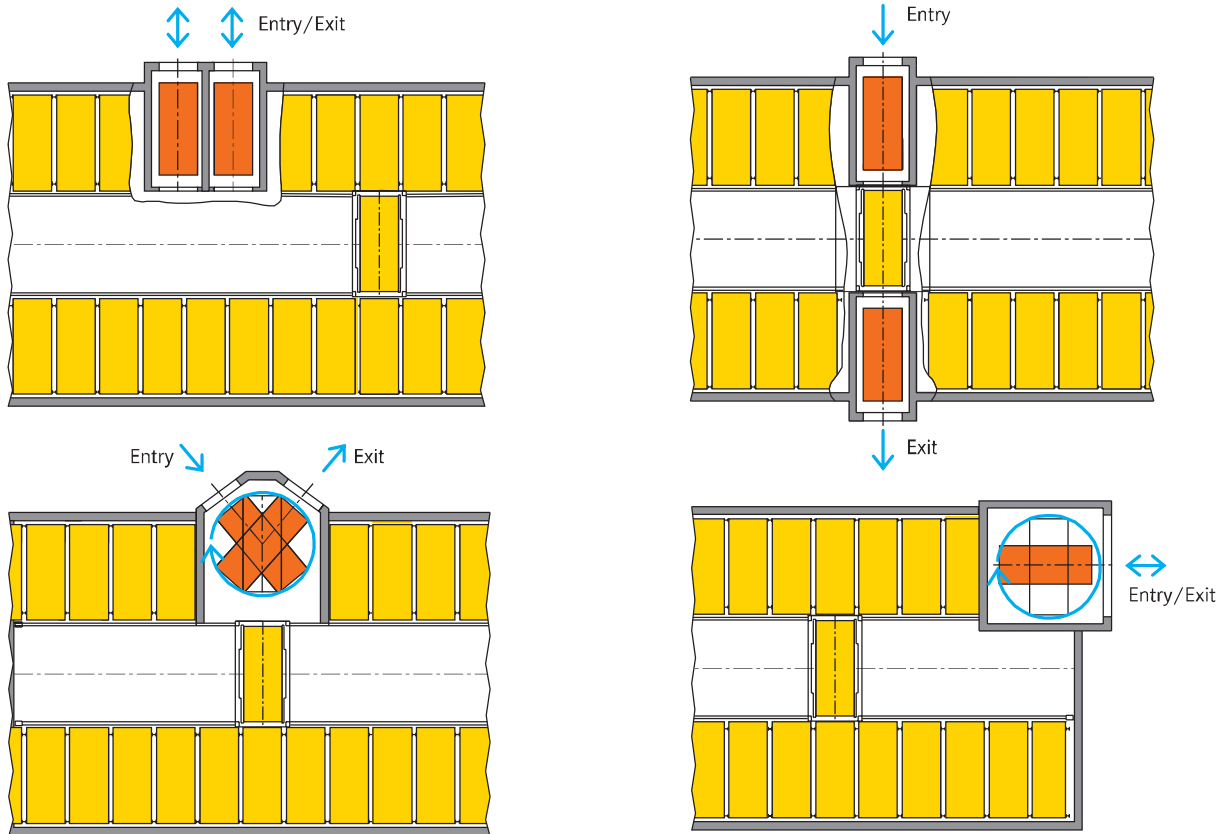

The arrangement of the transfer area is flexible. The optimum arrangement is always in the system center which has the shortest access times. Depending on the need and kind of utilisation, the number of the transfer areas can be adapted.

Maintenance access and switch cabinet

Maintenance access as well a room for the switch cabinet (min. 2 x 5 m) is required (please check with WÖHR).

Max. car dimensions

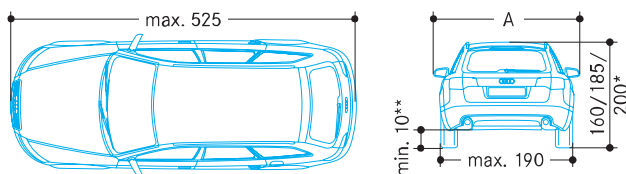

Pallet width	Dimension A
230	220

Car weight max. 2500 kg, wheel load max. 625 kg.

These car dimensions are valid for the building dimensions as mentioned. If building dimensions are adjusted, other car dimensions are possible.

* Overall height (cars with roof racks, roof rails, antennas etc. should not exceed the mentioned overall height).
 ** Clearance underneath the gear case

*Levanta***PARK**

TECHNICAL SPECIFICATION **HYPERLIFT**



SMART SOLUTIONS FOR VEHICLE PARKING AND CAR STORAGE

The Hyperlift is the largest platform lift available on the LevantaPARK product range capable of lifting vehicles and goods with people on board.

Utilising four columns and a unique design with interconnecting torsion bars all with independent hydraulic cylinders the platform has the capacity to lift 8000 kgs to a height of 14 meters with people on board in complete safety.

Guarding around the hydraulic cylinders, on board data connection through a phone network and photoelectric sensors make sure the vehicle or goods can be moved in a safe manner while providing a solution to moving heavy vehicles or goods safely between multiple floors levels.

SPECIFICATION TABLE

Model Number	Capacity	Standard Lifting Height	Max Lifting Height	Minimum Platform	Maximum Platform	Pit Depth	Power	Speed	Power Supply	Standard Weight	Notes
LP-HP80-4C	8000 kgs	4,000 mm	14,000mm	6,000 mm x 3,250 mm	7,950mm x 3950mm	1200 mm	3 x 7.5 kw	0.15 m/sec	415 v / 50 Hz	6500 kgs.	
LP-HP80 4C RG	8000 kgs	4,000 mm	14,000mm	6,000 mm x 3,250 mm	7,950mm x 3950mm	1400 mm	3 x 7.5 kw	0.15 m/sec	415 v / 50 Hz	6500 kgs.	Reverse Guides Option to ensure no columns protrude past top level of lift
LP-HP50 4CRT	5000 kgs	4,000 mm	14,000mm	6,000 mm x 3,250 mm	7,950mm x 3950mm	1400 mm	3 x 7.5 kw	0.15 m/sec	415 v / 50 Hz	8500 kgs.	Comes with integrated Roof that can be tiled - Capacity of Roof is 3000 kgs

HYPERLIFT LP-HP50 4CRT

HYPERLIFT COLLAPSED
FRONT VIEW

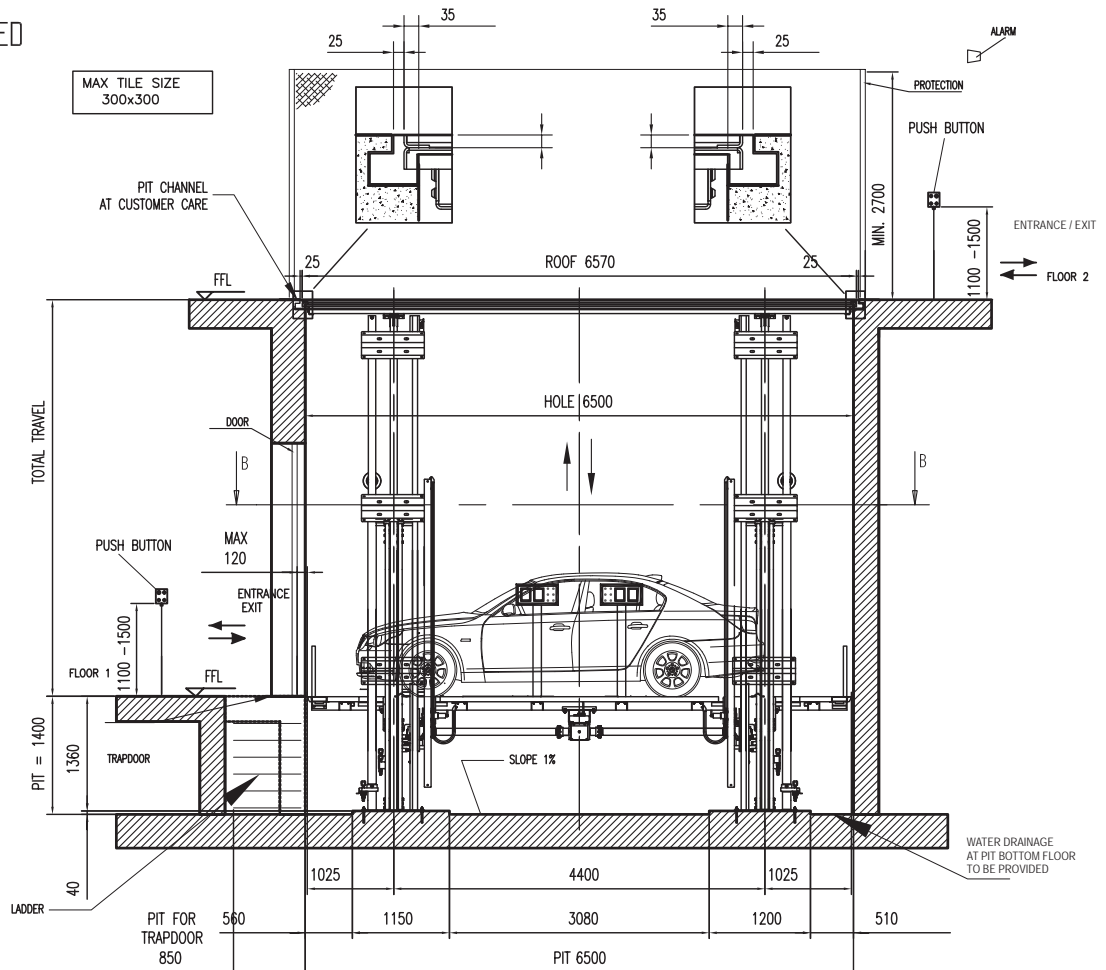

HYPERLIFT LIFTED FRONT VIEW

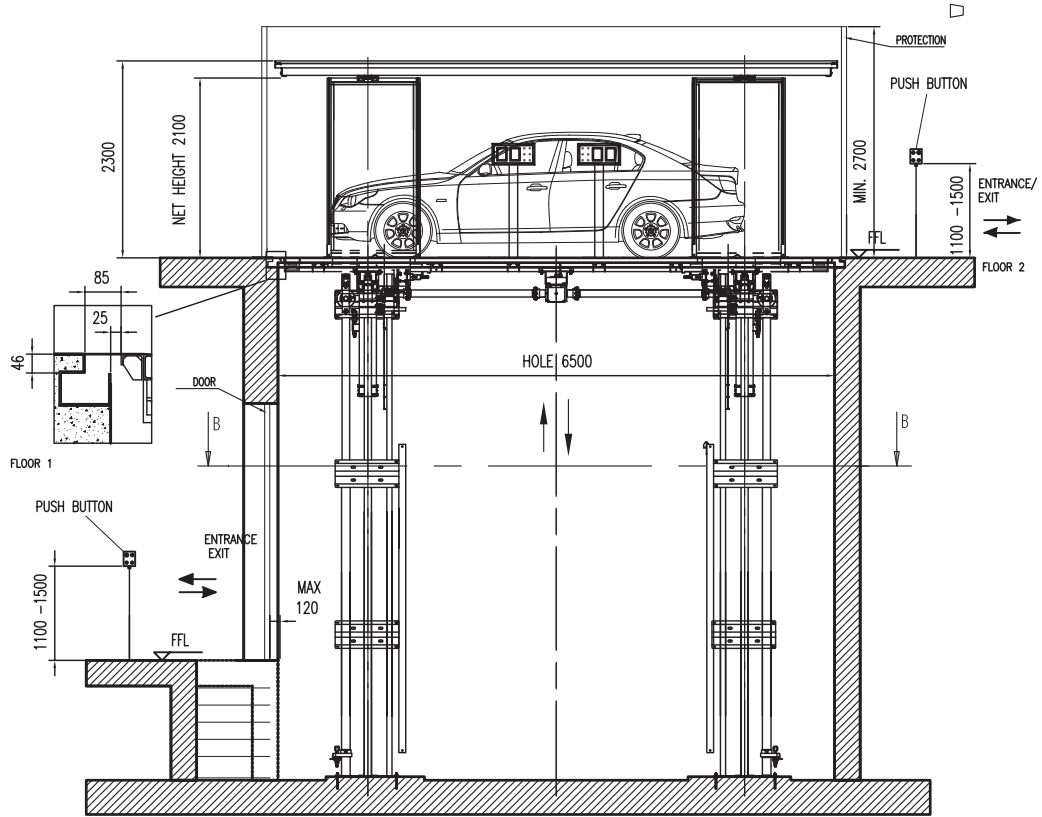

SIDE VIEW

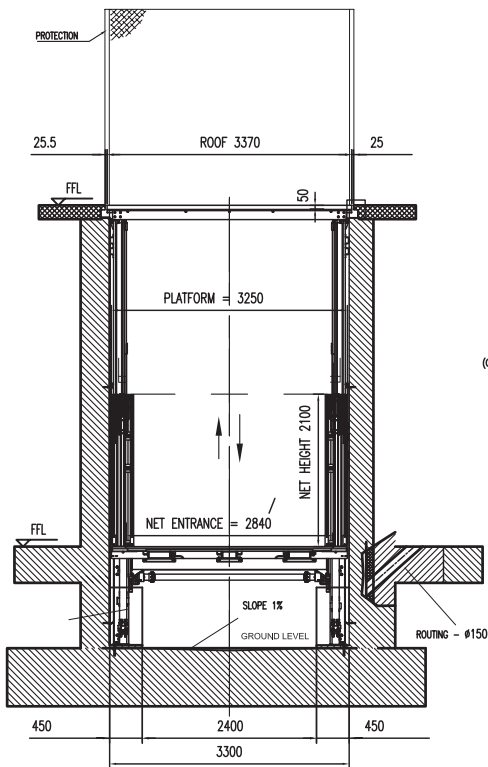

SECTION B-B

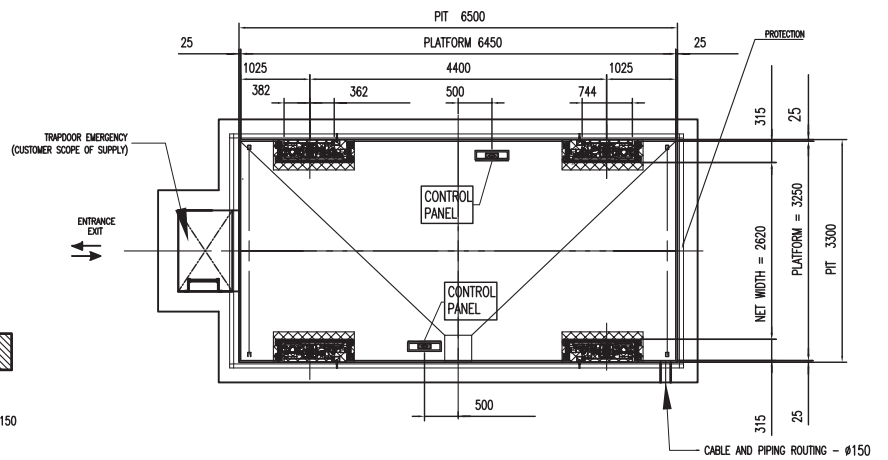

TECHNICAL SPECIFICATION HYPERLIFT

ACCESSORIES

■ STANDARD □ OPTIONAL

DESCRIPTION	HYPERLIFT	HYPERLIFT + T	NOTES
Standard colours: SILVER RAL 9006	■	■	
No. 4 columns complete with lifting cylinders and tooth racks	■	■	
No. 1 platform with metal smooth staves	■	■	
No. 1 balance system with 5 torsion bars	■	■	
No. 2 "Dead man present" push button boards with key	■	■	
Push button board design style	■	■	
Security control module for sensors and safety locks	■	■	
Emergency auto-dialer	■	■	Based on AS1418.8
Back up battery for auxiliary circuits	■	■	Allows emergency descent with platform not on floor
No. 1 hydraulic pump with motor	■	■	
No. 1 Electrical panel board	■	■	
No. 2 Electrical magnetic sensors	■	■	
Standard power supply 415V/3Ph/50hz	■	■	
No. 1 slowing kit	■	■	
No. 1 Acoustic warning	■	■	
No. 4 protections on a columns side	■	■	Height = 2000 mm
No. 2 stopping wheel L=745 mm	■	■	
Photocell barriers H=600 mm. for forward and backward control	■	■	
Adjustable Floor mechanical locking devices	■	■	
Emergency descent maneuver (with manual pump)	■	■	
Nylon Package	■	■	
Screws anchors	■	■	
Roof in diamond checker plate		■	Roof transittable: 3000 kg. (Not suitable to lift a vehicle)
Tileable roof		□	Roof transittable: 3000 kg. (Not suitable to lift a vehicle)
Tileable roof in stainless steel		□	
Additional push button board at the floor	□	□	
Additional push button board with upright for double entrance/exit	□	□	
Push button board in stainless steel	□	□	
Push button board on platform in stainless steel	□	□	
Electro mechanical lock	□	□	For manual doors control
Additional key for push button	□	□	
Additional Electromagnetic sensors	□	□	
Outside pulse recall for each push button board	□	□	Applicable just on enclosed shaft
Pulse command return to home position button (just with pulse maneuver)	□	□	Applicable just on enclosed shaft
Automatic repositioning to the floor in case of fire	□	□	Applicable just on enclosed shaft
Remote control each receiver	□	□	Max. ray 5 mt
Remote control each transmitter	□	□	Max. ray 5 mt
Flashing light	□	□	

ACCESSORIES

■ STANDARD □ OPTIONAL

DESCRIPTION	HYPERLIFT	HYPERLIFT + T	NOTES
Siren	□	□	
N° 4 photocells barriers for roof perimetric control	□	□	To install along with the laser scanner
Additional acoustic warning	□	□	
2 colors traffic light (Red / Green)	□	□	
LED lights low voltage on platform	□	□	
Soft Starter	□	□	
Additional cost for waterproof push button board IP 54	□	□	
Handrail H = 1.200 mm. (per meter)	□	□	Available as either fixed or removable*
Photocell barrier for doors' area control H = 150 mm	□	□	
Photocell barrier for doors' area control H = 300 mm	□	□	
Control photocells for car's height (X 2)	□	□	
Laser scanner for control area		□	
Sheet cover in diamond alluminium	□	□	
Complete lateral protection	□	□	
Non standard power supply	□	□	On request
Hydraulic pump with low acoustic emission	□	□	On request
Non standard colour*	□	□	
Hot dip galvanization (platform, columns and guides)	□	□	

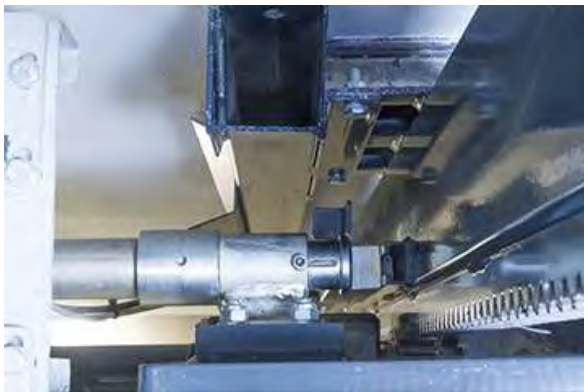

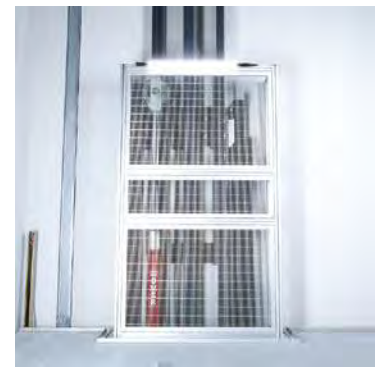

The platform has a 2.50 m high guard which can only be removed using special maintenance tools, thus preventing contact with the moving parts of the platform (complaint with EC 2006/42).



Interconnecting torsion bars ensure that regardless of where the weight is placed on the platform it will rise consistently and evenly across the width and length.

COMPLIANCE DATA

HYPERLIFT SYSTEMS CONFORM TO

- AS 3000
- AS Part 1601
- ISO 9001
- AS 60204
- AS1217.1
- EN14010
- AS1418.8



Engineered & Manufactured in Europe



Designed for Australian site conditions

QLD	- 17 Canberra Street	Hemmant	QLD	4174
NSW	- 89 Gascoigne Street	Kingswood	NSW	2747
VIC	- 135 Northcorp Boulevard	Broadmeadows	VIC	3043
SA	- 6 Sheffield Street	Woodville North	SA	5012
WA	- 67 Tacoma Circuit	Canning Vale	WA	6155



Smart Solutions for Vehicle Parking and Car Storage



Product of

OMER

*All technical information provided is subject to change without notice.
All information is copyright © 2018 LevantaPARK - 1/18*